

Modellname: **FLY**
 Nazwa modelu:

Modellreihe: **23 -- FL**
 Numer modelu:

Type: **21**
 Typ:

Blatt Nr **1** von: **5**
 Strona z:

MONTAGEANLEITUNG INSTRUKCJA MONTAŻOWA



Typ:L

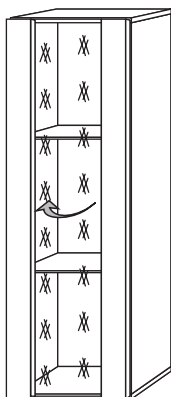

Typ:P

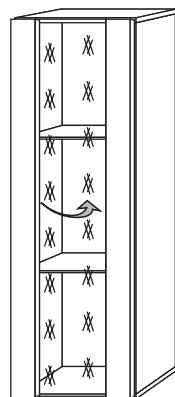

2 Personen
2 Osoby

Pflegehinweis!

Bitte nur mit einem Staubtuch oder einem feuchten Lappen reinigen.

KEINE scheuernde Putzmittel verwenden!

Wskazówka dotycząca pielęgnacji!

Proszę czyścić tylko suchą lub lekko wilgotną szmatką do kurzu. Nie używać żadnych środków szorstkich!

Max. zulässige Belastungen von Einlegeböden in kg:

Maksymalne obciążenie półek w kg:

Stärke/Gr.	Spanplatte/Płyta		
Länge/Dł. mm	15	18	22
0<400			
401<600	40	40	40
601<800	24		
801<1000	15	30	

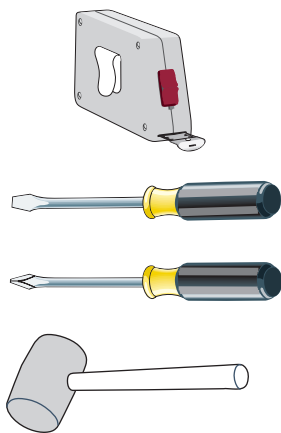
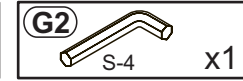
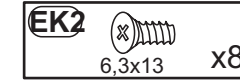
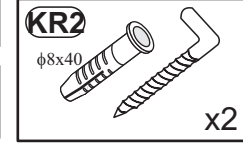
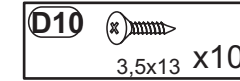
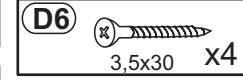
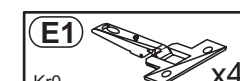
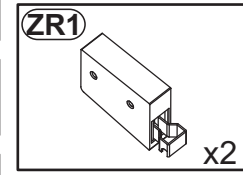
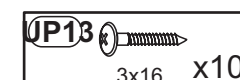
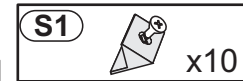
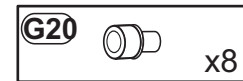
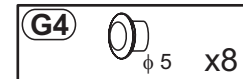
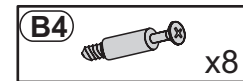
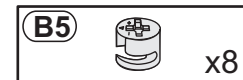
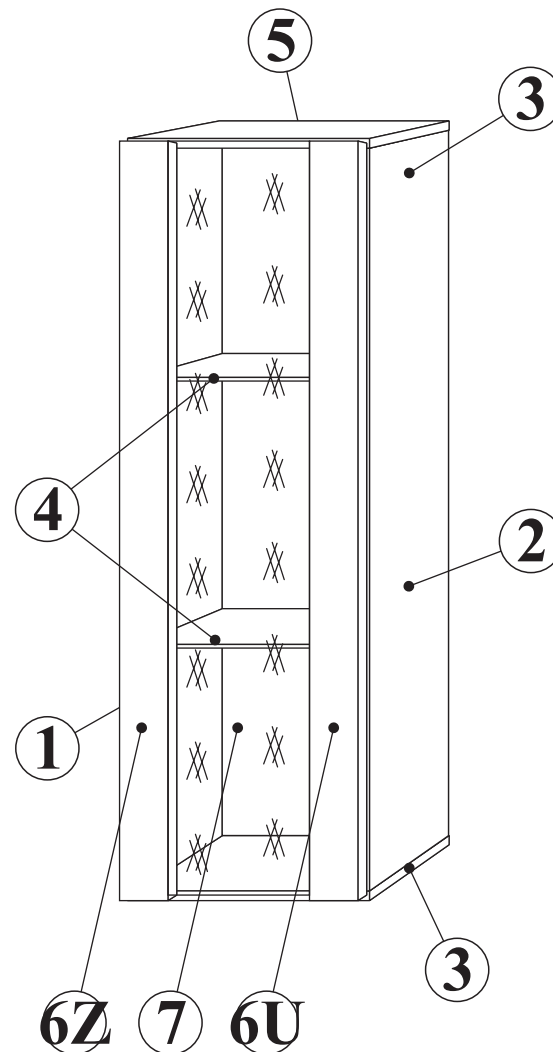

Modellname: **FLY**
 Nazwa modelu:

Modellreihe: **23 -- FL**
 Numer modelu:

Type: **21**
 Typ:

Blatt Nr 2 von: 5
 Strona z:

1

Typ:L

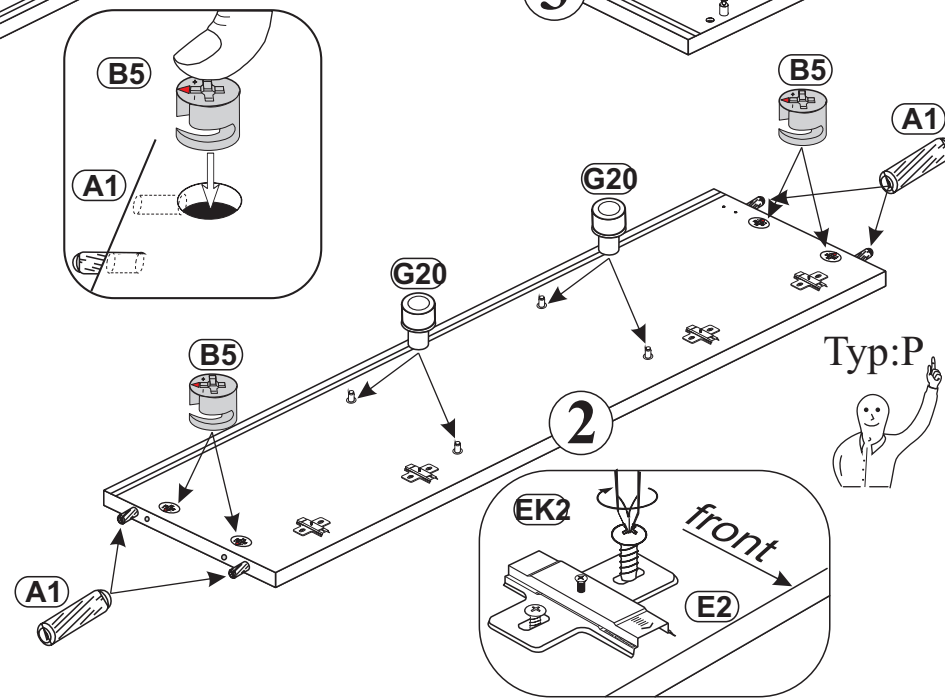
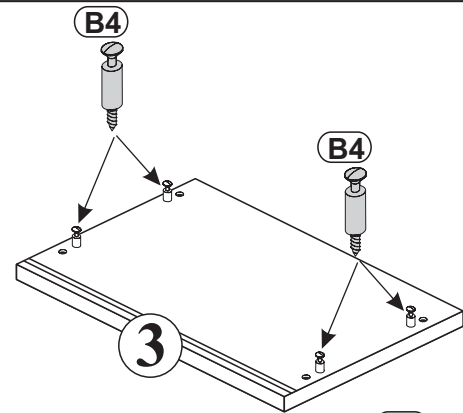
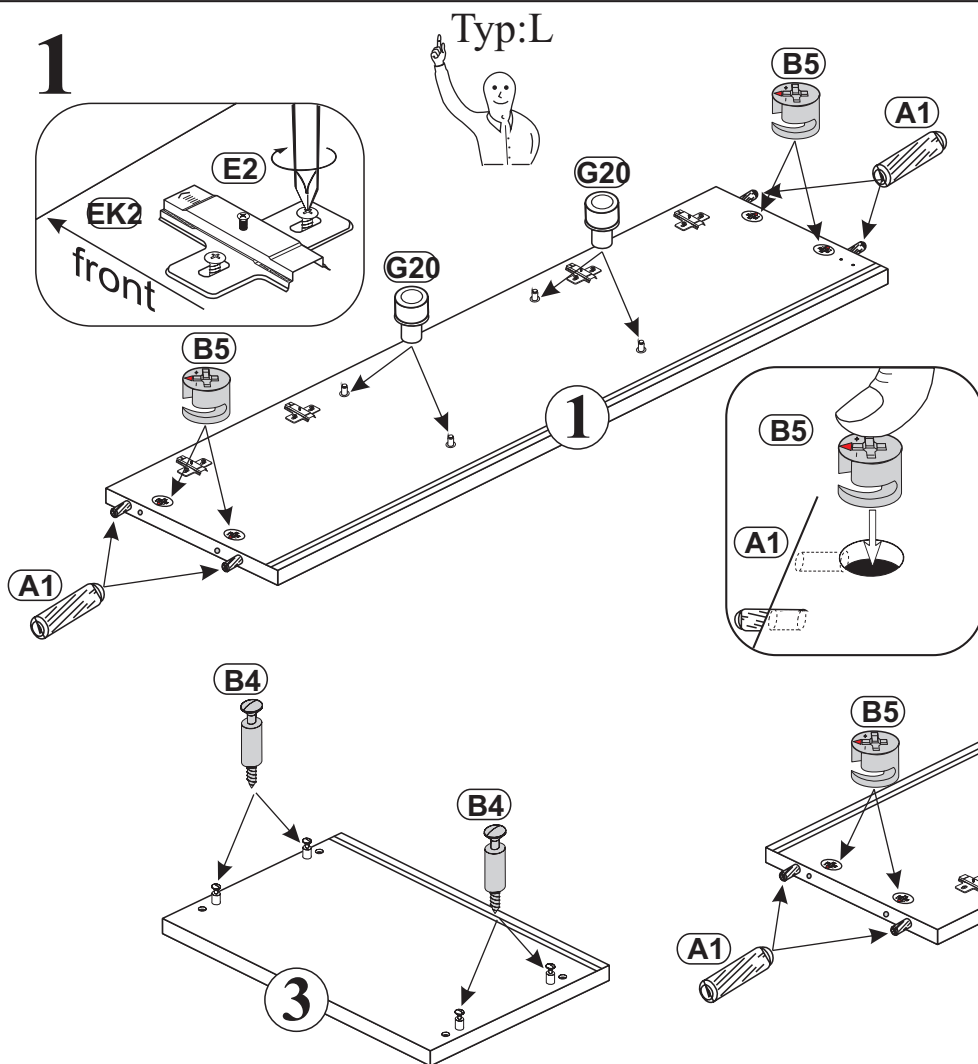

- | | |
|-----------------------------|---------------------------|
| E1
Kr0
x4 | A1
φ 8x36
x8 |
| D10
3,5x13
x12 | B5
x8 |
| E2
H0
x4 | B4
x8 |
| EK2
6,3x13
x8 | G20
x8 |
| UP13
3x16
x10 | |
| P1
x10 | |

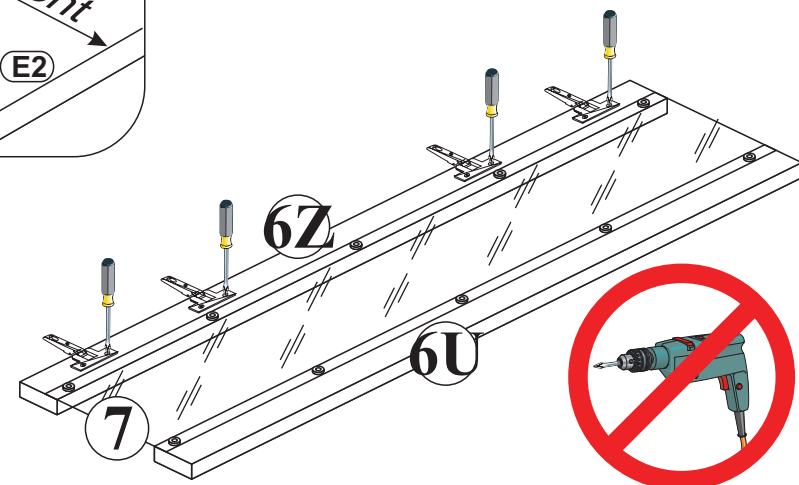
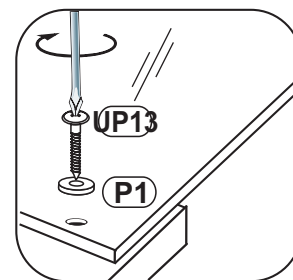
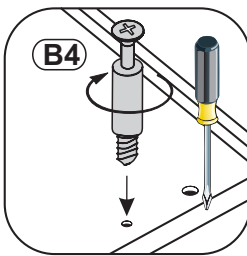
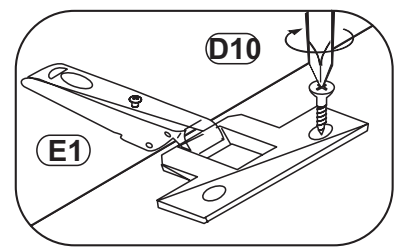

2

Typ:L

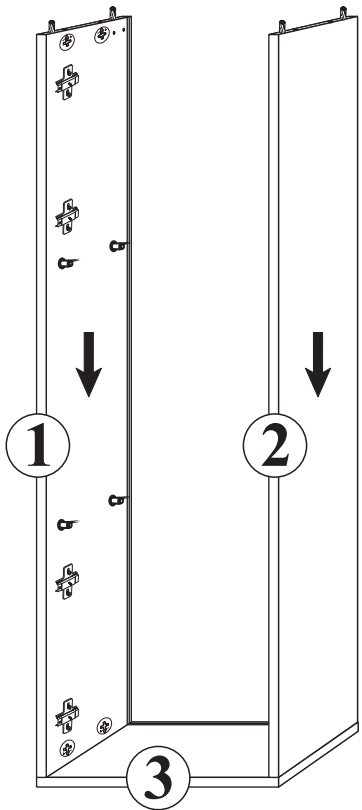

Typ:P

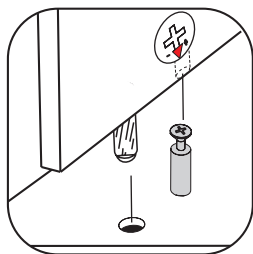
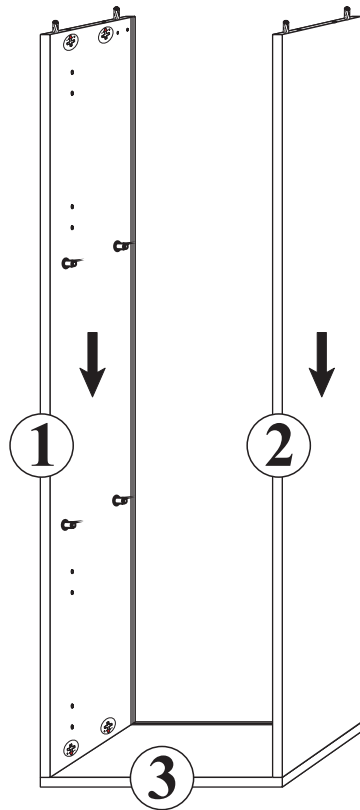

3

Typ:L

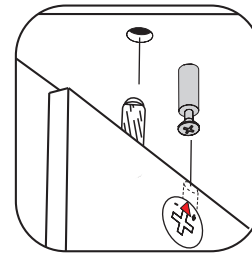
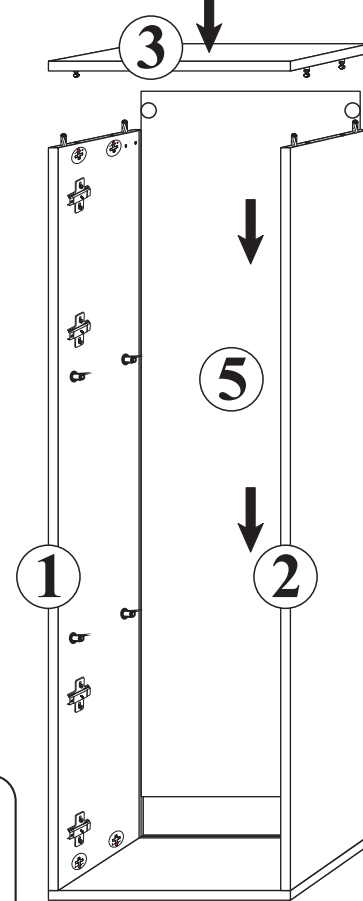

Typ:P

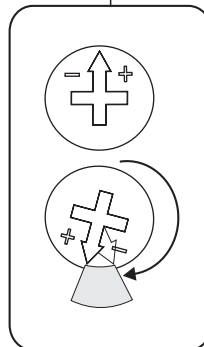
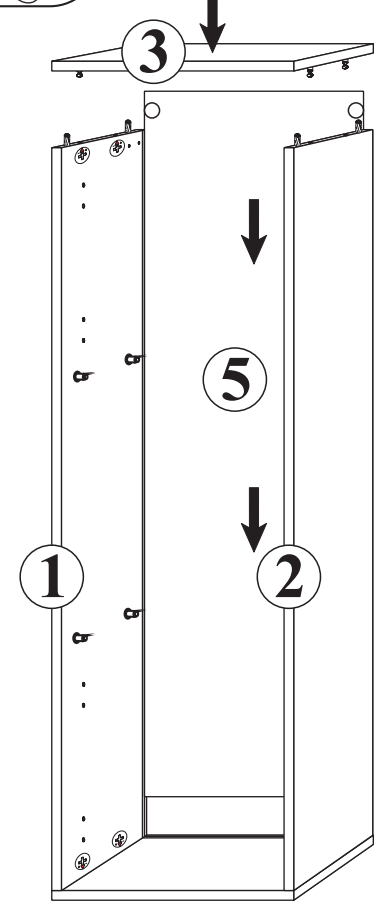

4



a=b

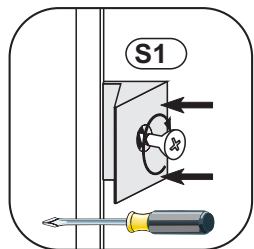
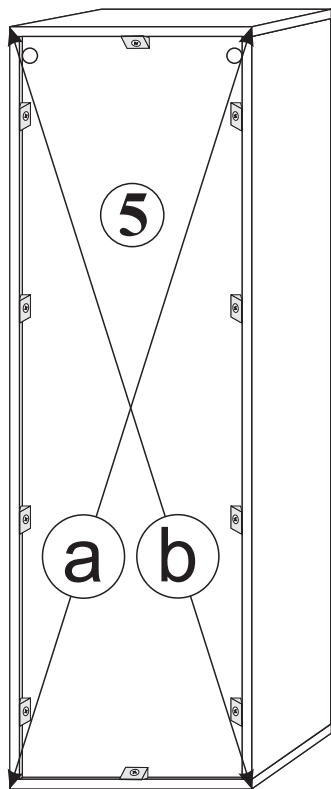

5

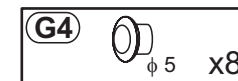
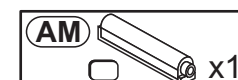
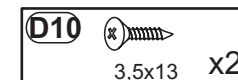
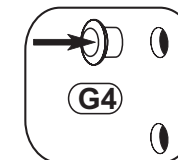
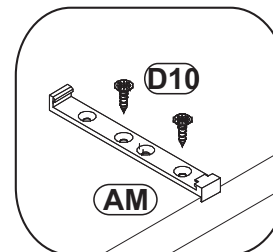
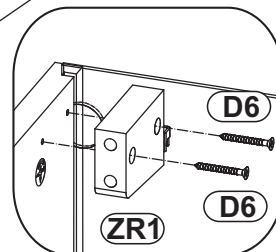
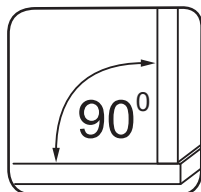
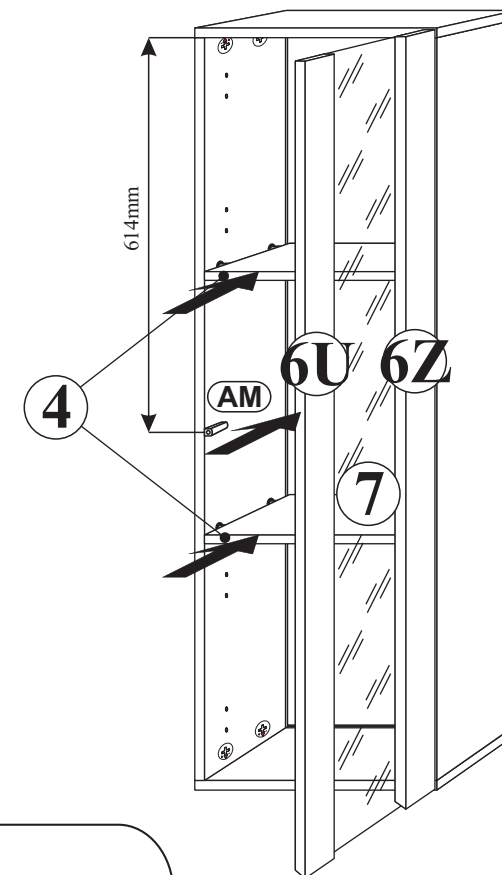
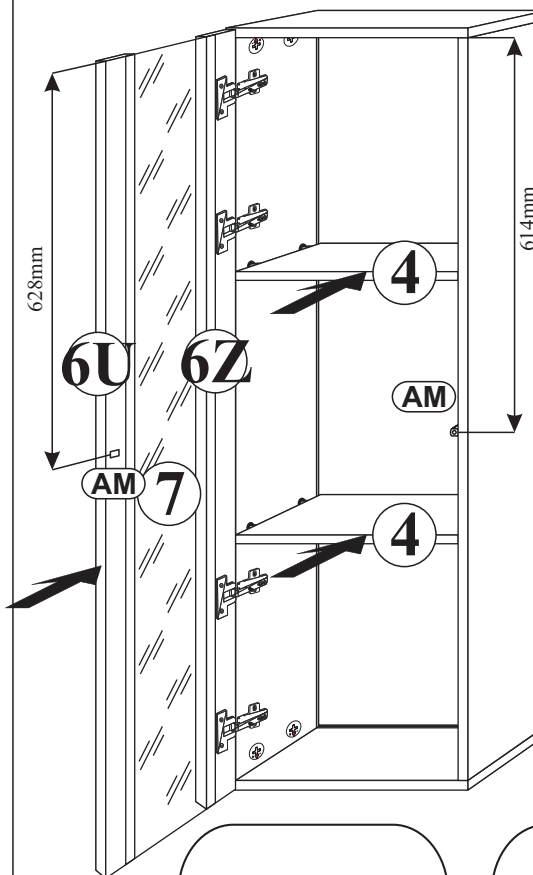
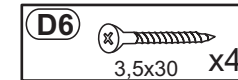
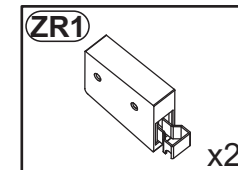
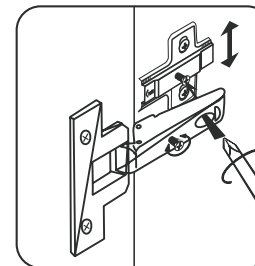
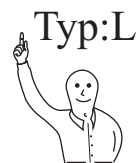

6

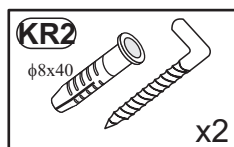
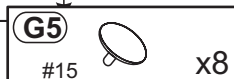
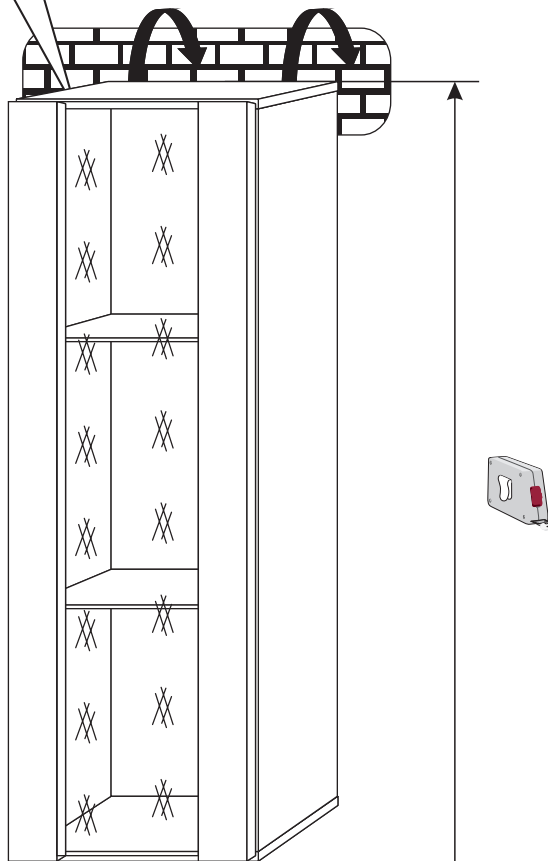
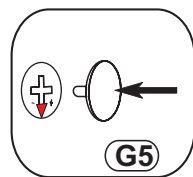
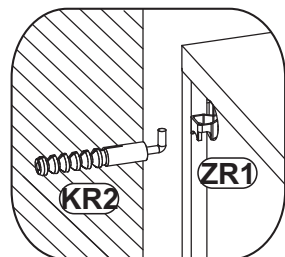

PL

Załączone kołki do zawieszania bryty, do stosowania wyłącznie do ścian betonowych, do innych ścian należy odpowiednio dokupić.

D

Die beigefügten Dübel zum Aufhängen des Elements dürfen nur bei Betonwänden eingesetzt werden, bei anderen Wandarten müssen entsprechende Dübel zugekauft werden.

Verstellmöglichkeiten

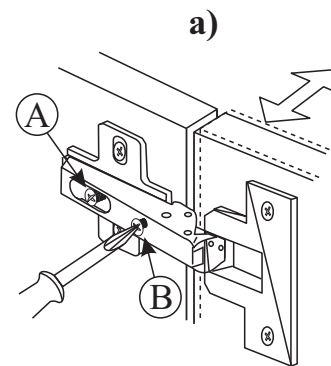

a) Fugenverstellung:
 Befestigungsschraube "A" lockern, gewünschte Fuge mit Schraube "B" einstellen, Schraube "A" anziehen.

b) Tiefenverstellung:
 Befestigungsschraube "A" lockern, Bandarm nach vorne oder rückwärts verschieben, Schraube "A" anziehen, Schraube "B" mit einer 1/4 Drehung nach rechts arretieren.

c) Höhenverstellung:
 Befestigungsschraube "C" lockern, Höhe einstellen, Schraube "C" anziehen.

Instructions for hinge adjustment

a) Side adjustment:
 Loosen fixing screw "A", adjust gap with screw "B" and retighten screw "A".

b) Depth adjustment:
 Loosen fixing screw "A", push hinge arm forwards or backwards, retighten screw "A", fix screw "B" with a 1/4-turn in clock-wise direction.

c) Height adjustment:
 Loosen screw "C", adjust height, retighten screw "C".

Les possibilités de positionnement

a) Positionnement de la rainure:
 Desserrer la vis de fixation "A", positionner avec la vis "B" la rainure (joint) souhaitée et resserrer la vis "A".

b) Positionnement de la profondeur:
 Desserrer la vis de fixation "A" (1 tour), régler la profondeur et resserrer la vis "A".

c) Positionnement de la hauteur:
 Desserrer la vis de fixation "C" (1 tour), positionner la hauteur et resserrer la vis "C".

Możliwości regulacji

a) Regulacja szczeliny:
 Poluzować wkręt "A", wkrętem "B" ustawić odpowiednią szczelinę, dokręcić wkręt "A".

b) Regulacja głębokości:
 Poluzować wkręt "A" (1 obrót), ustawić głębokość, dokręcić wkręt "A".

c) Regulacja wysokości:
 Poluzować wkręt "C" (1 obrót), dokonać regulacji wysokości położenia drzwi, wkręt "C" dokręcić.

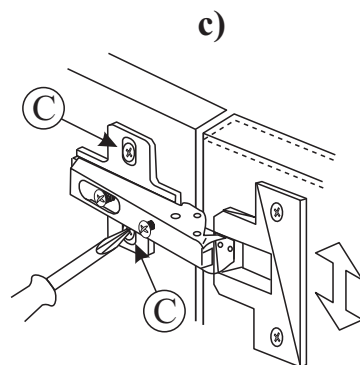
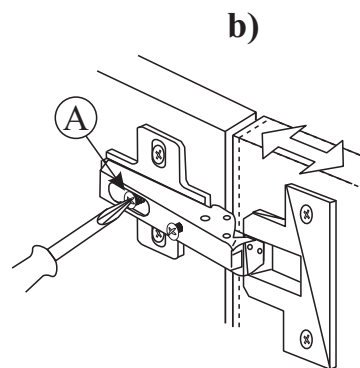

MONTAGEANLEITUNG
INSTRUKCJA MONTAŻOWA

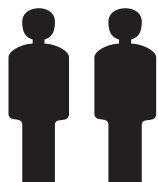

2 Personen
2 Osoby

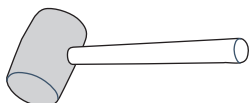
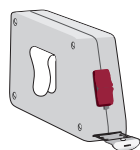
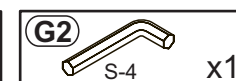
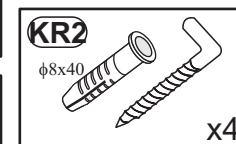
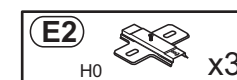
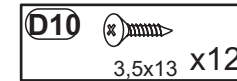
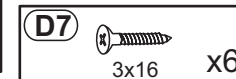
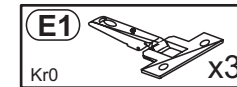
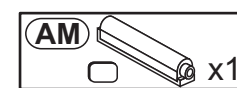
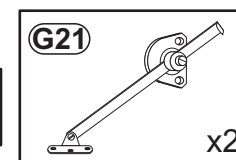
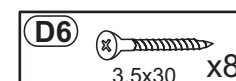
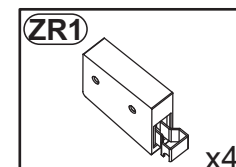
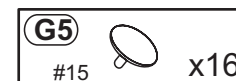
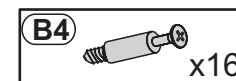
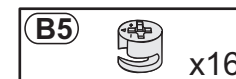
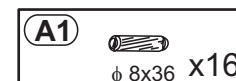
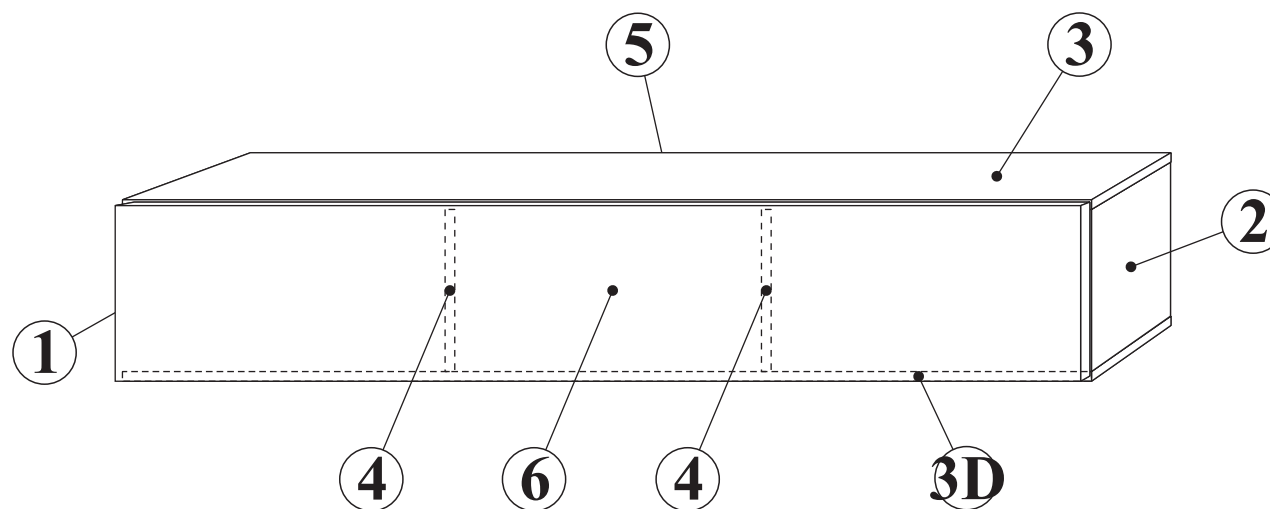

Max. zulässige Belastungen von Einlegeböden in kg:

Maksymalne obciążenie półek w kg:

Stärke/Gr. Länge/Dł. mm	Spanplatte/Płyta		
	15	18	22
0<400			
401<600	40	40	40
601<800	24		
801<1000	15	30	

Pflegehinweis!

Bitte nur mit einem Staubtuch oder einem feuchten Lappen reinigen.

KEINE scheuernde Putzmittel verwenden!

Wskazówka dotycząca pielęgnacji!

Proszę czyścić tylko suchą lub lekko wilgotną szmatką do kurzu. Nie używać żadnych środków szorstkich!

Modellname: **FLY**
Nazwa modelu:

Modellreihe: **23 -- FL**
Numer modelu:

Type: **30**
Typ:

Blatt Nr **2** von: **5**
Strona **2** z: **5**

1

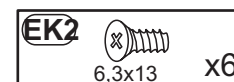
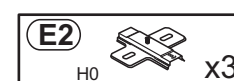
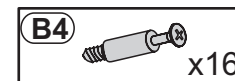
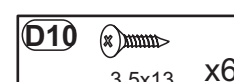
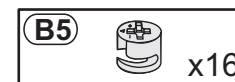
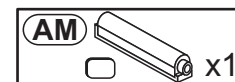
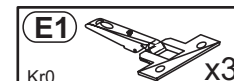
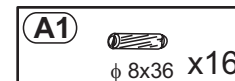
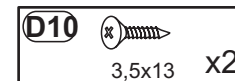
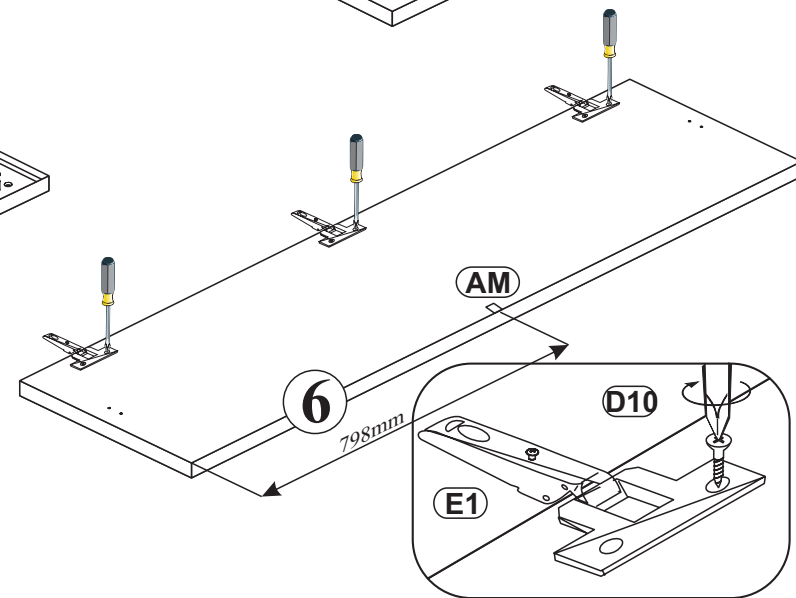
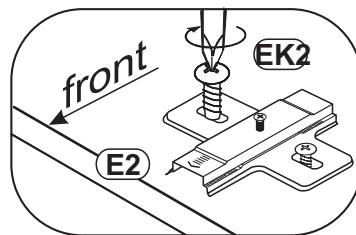
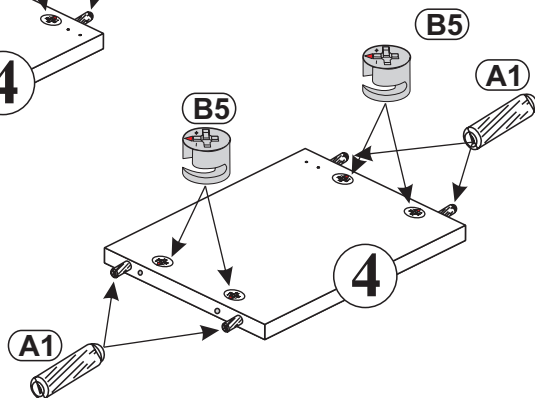
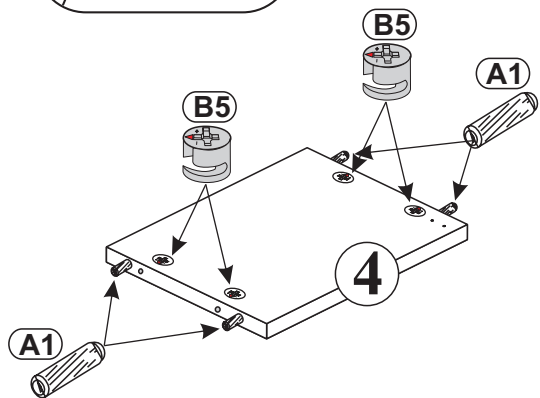
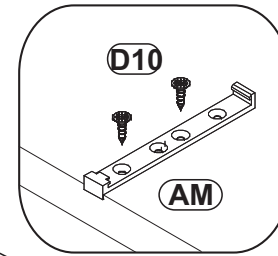
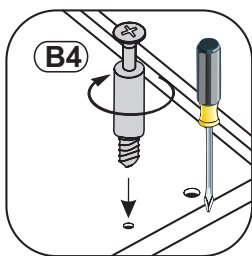
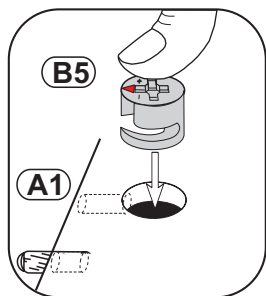
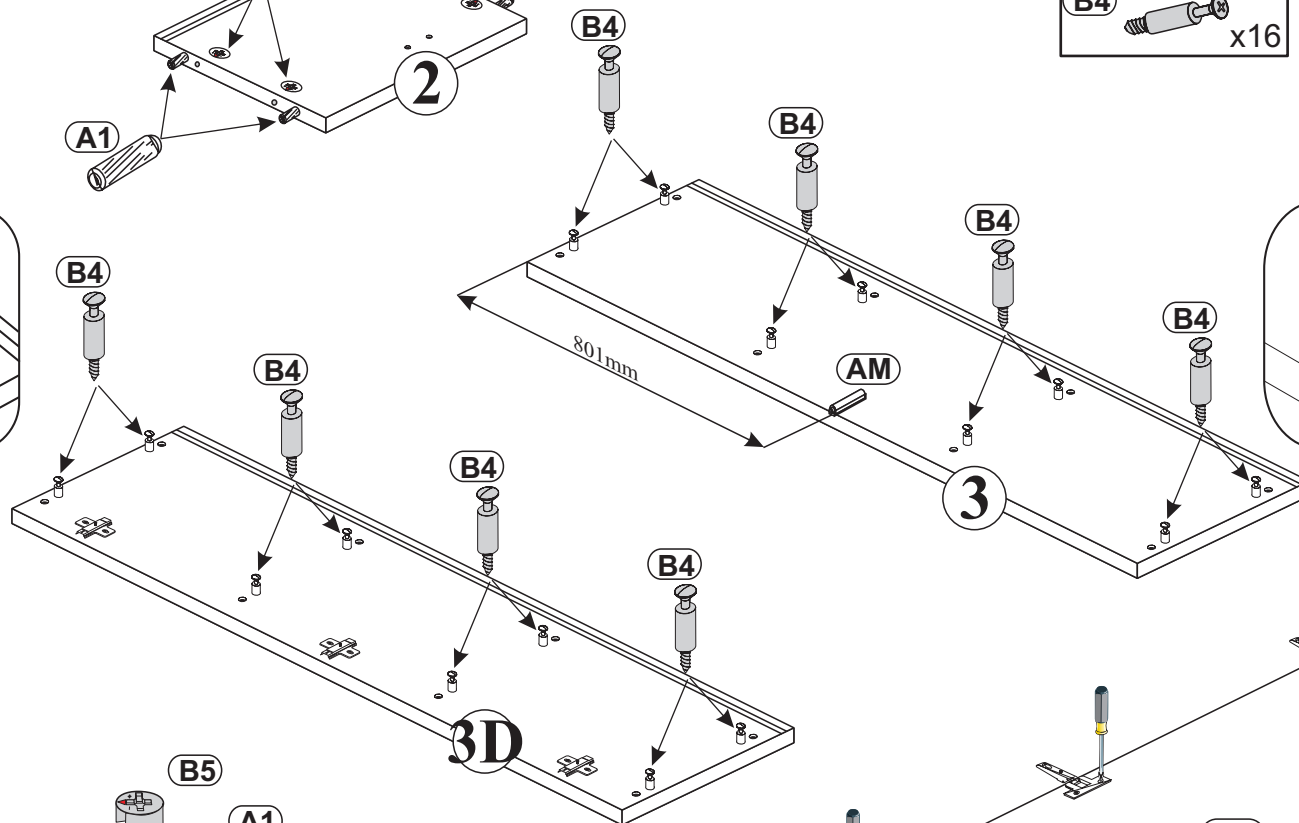
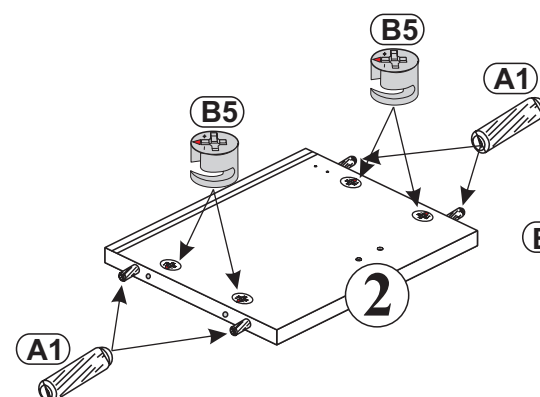
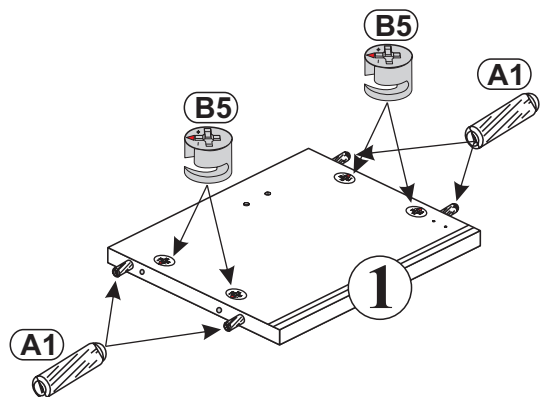

2

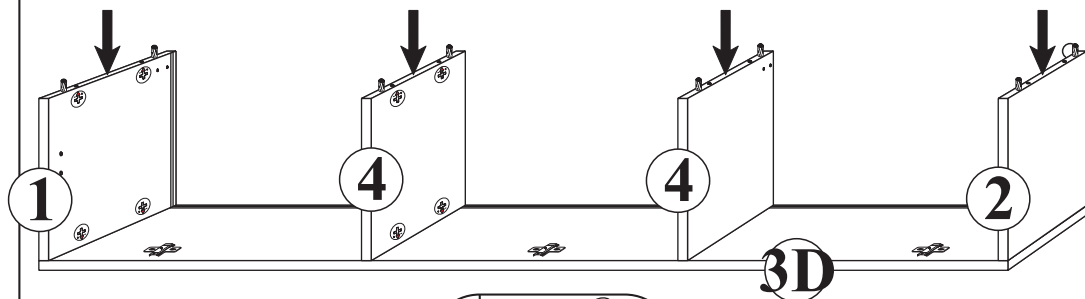

3D

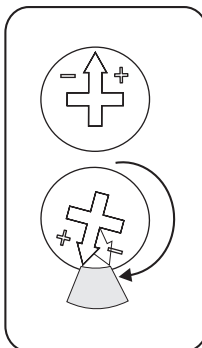
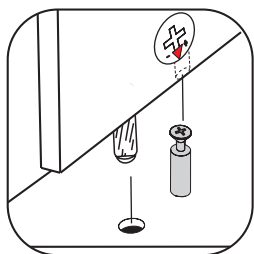
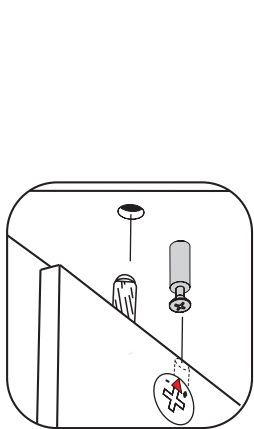

3

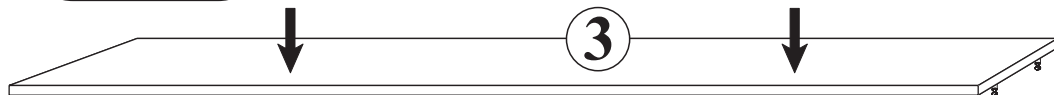

5

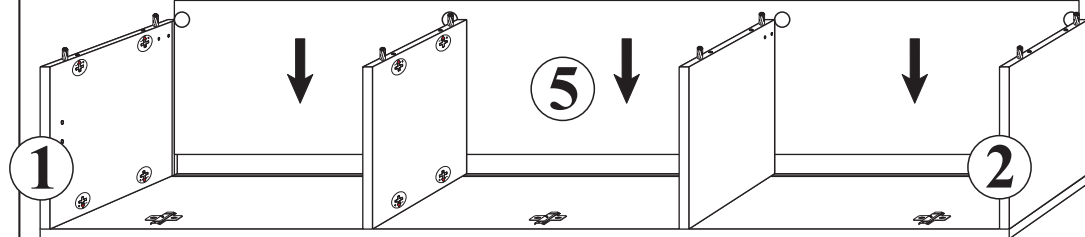

3

a=b

S1  **x12**

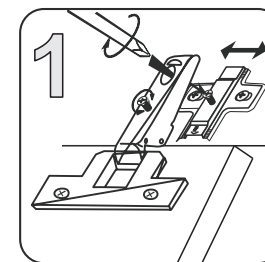
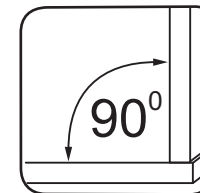
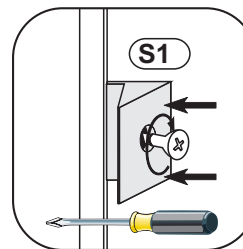
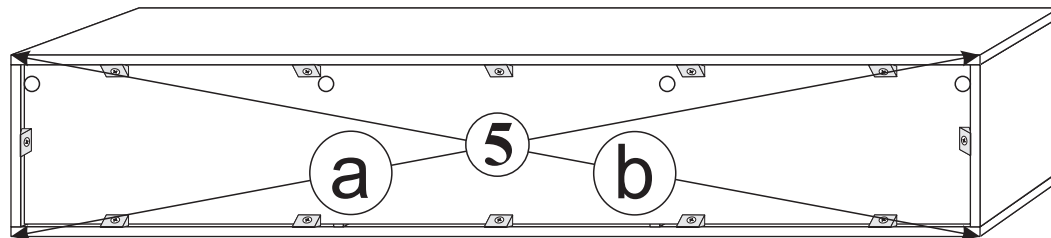

6

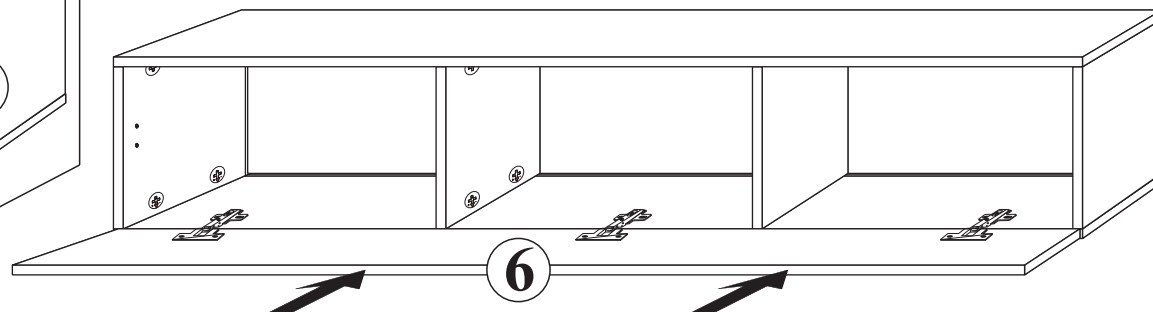

4

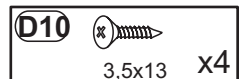
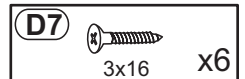
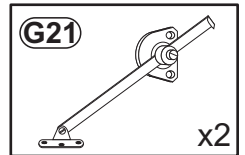
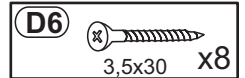
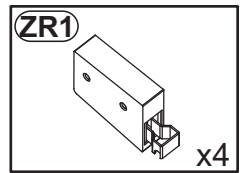
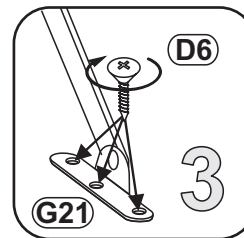
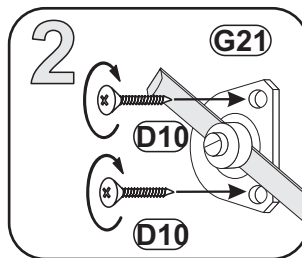
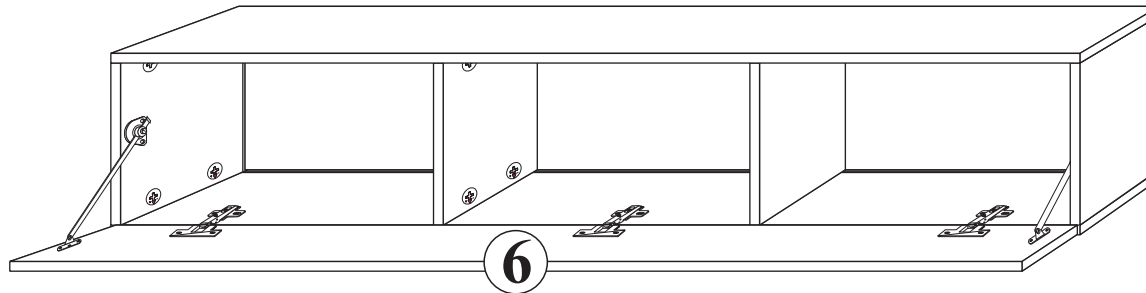
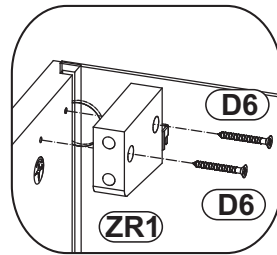

5

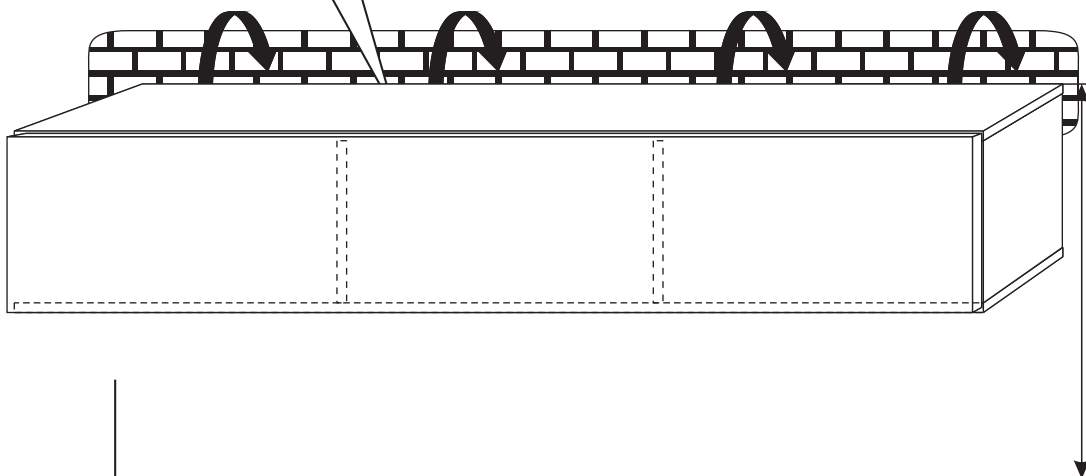
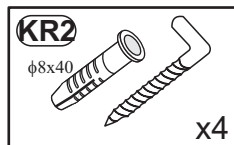
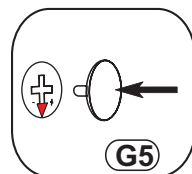
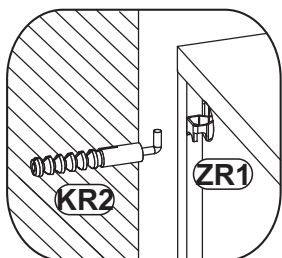

PL

Załączone kołki do zawieszania bryty, do stosowania wyłącznie do ścian betonowych, do innych ścian należy odpowiednio dokupić.

D

Die beigefügten Dübel zum Aufhängen des Elements dürfen nur bei Betonwänden eingesetzt werden, bei anderen Wandarten müssen entsprechende Dübel zugekauft werden.

Verstellmöglichkeiten

- a) Fugenverstellung:
 Befestigungsschraube "A" lockern, gewünschte Fuge mit Schraube "B" einstellen, Schraube "A" anziehen.
- b) Tiefenverstellung:
 Befestigungsschraube "A" lockern, Bandarm nach vorne oder rückwärts verschieben, Schraube "A" anziehen, Schraube "B" mit einer 1/4 Drehung nach rechts arretieren.
- c) Höhenverstellung:
 Befestigungsschraube "C" lockern, Höhe einstellen, Schraube "C" anziehen.

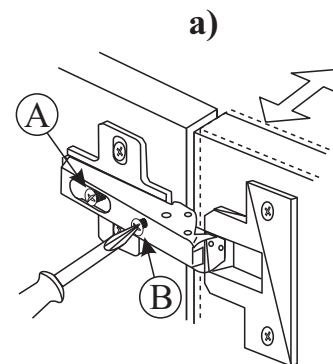

Instructions for hinge adjustment

- a) Side adjustment:
 Loosen fixing screw "A", adjust gap with screw "B" and retighten screw "A".
- b) Depth adjustment:
 Loosen fixing screw "A", push hinge arm forwards or backwards, retighten screw "A", fix screw "B" with a 1/4-turn in clock-wise direction.
- c) Height adjustment:
 Loosen screw "C", adjust height, retighten screw "C".

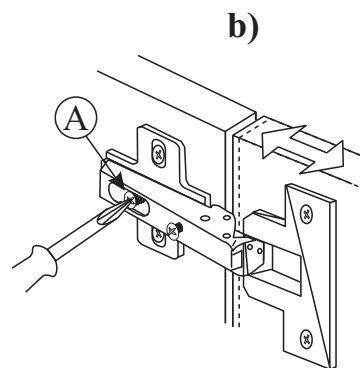

Les possibilités de positionnement

- a) Positionnement de la rainure:
 Desserrer la vis de fixation "A", positionner avec la vis "B" la rainure (joint) souhaitée et resserrer la vis "A".
- b) Positionnement de la profondeur:
 Desserrer la vis de fixation "A" (1 tour), régler la profondeur et resserrer la vis "A".
- c) Positionnement de la hauteur:
 Desserrer la vis de fixation "C" (1 tour), positionner la hauteur et resserrer la vis "C".

Możliwości regulacji

- a) Regulacja szczeliny:
 Poluzować wkręt "A", wkrętem "B" ustawić odpowiednią szczelinę, dokręcić wkręt "A".
- b) Regulacja głębokości:
 Poluzować wkręt "A" (1 obrót), ustawić głębokość, dokręcić wkręt "A".
- c) Regulacja wysokości:
 Poluzować wkręt "C" (1 obrót), dokonać regulacji wysokości położenia drzwi, wkręt "C" dokręcić.

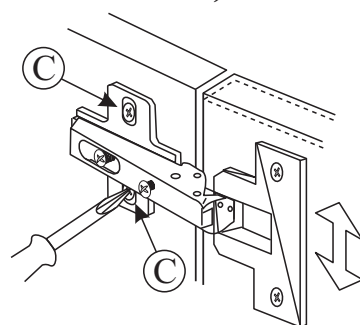

MODELL: PW MIX 22_MX Typ MX

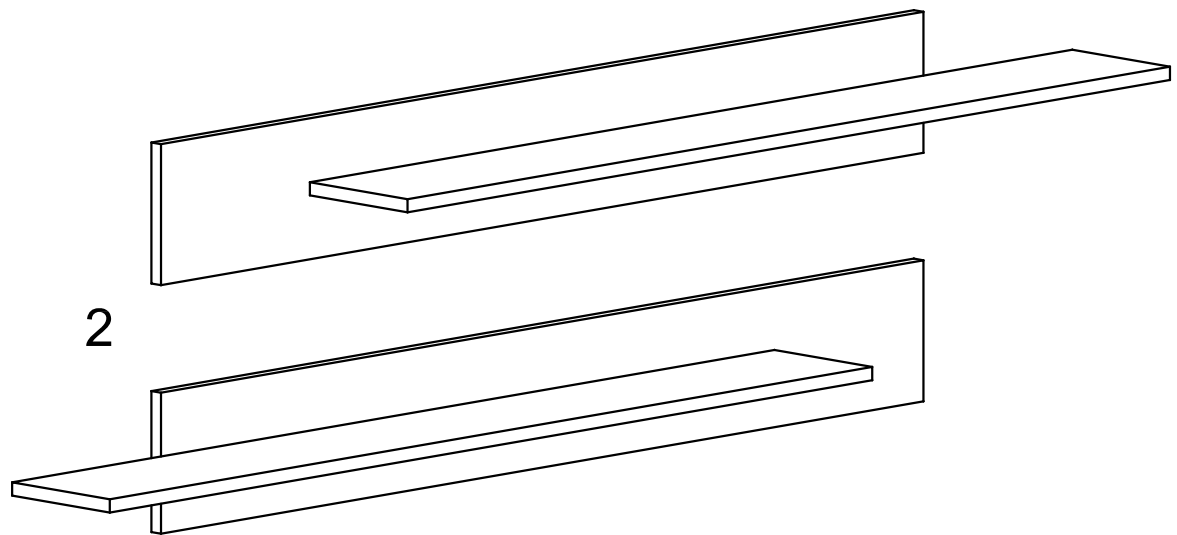
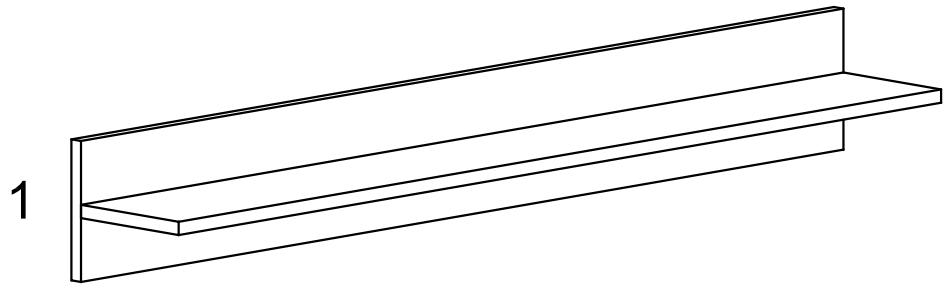

- (D) Montageanleitung (GB) Assembly instructions
(NL) Montage-instructies (PL) Instrukcja montażu
(TR) Montaj Talimatları (RU) Инструкция по монтажу

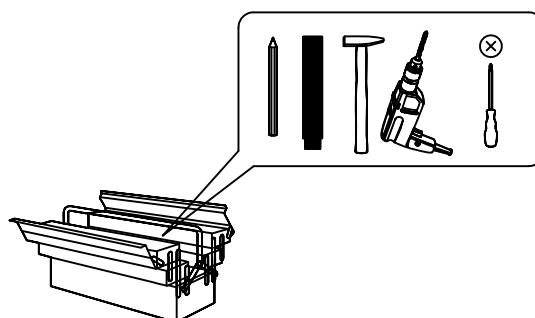

Sicherheitshinweise • Safety instructions • Veiligheidsinstructies •
Wskazówki bezpieczeństwa • Güvenlik uyarıları ? Правила техники безопасности

D	Bitte nur mit einem Staubtuch oder leicht feuchtem Lappen reinigen. Keine scheuernden Putzmittel verwenden.
GB	Please only clean with a duster or a damp cloth. Do not use any abrasive cleaners.
NL	Reinig alleen met een stofdoek of een lichtjes vochtige doek. Gebruik geen schurende poetsmiddelen.
PL	Czyszczenie należy wykonać wyłącznie za pomocą ściereczki lub lekko nawilżonego ręcznika. Nie stosować środków czyszczących do szorowania.
TR	Lütfen sadece bir toz beziyle veya hafif nemli yumuşak bir bezle siliniz. Aşındırıcı temizlik malzemeleri kullanmayınız.
RU	Очищайте от пыли тряпкой или слегка влажной ветошью. Не допускается применение чистящих средств, не предназначенных для ухода за мебелью.
D	Das Produkt ist nicht für die Anwendung im Freien geeignet.
GB	The product is not suitable for outdoor use.
NL	Het product is niet geschikt voor het gebruik in open lucht.
PL	Produkt nie jest przystosowany do zastosowań na wolnym powietrzu.
TR	Bu ürün açık havada kullanılmaya uygun değildir.
RU	Изделие не предназначено для использования вне помещений.
D	Überschreiten Sie die angegebenen Maximalbelastungen nicht. Andernfalls kann das Möbelstück beschädigt oder zerstört werden.
GB	Do not exceed the maximum loads specified. Otherwise, the furniture may sustain damage or be irreparably damaged.
NL	Overschrijd de aangegeven maximale belastingen niet. Anders kan het meubelstuk worden beschadigd of vernield.
PL	Nie wolno przekraczać podanych maksymalnych wartości obciążenia. W innym przypadku można mebel uszkodzić lub zniszczyć.
TR	Belirtilen azami yük değerini aşmayınız, aksi takdirde mobilya parçası zarar görebilir veya kullanılamaz hale gelebilir.
RU	Не допускается превышение указанных максимальных нагрузок. В противном случае возможно повреждение или разрушение мебели.
D	Schützen Sie Ihre Möbel generell vor Wasser (z.B. beim Wischen oder Blumen gießen). Die Feuchtigkeit kann in das Möbelstück eindringen und es beschädigen
GB	In general, keep water away from your furniture (e. g. when mopping or watering plants). The moisture may penetrate the furniture and damage it.
NL	Bescherm uw meubelen doorgaans tegen water (bijv. bij het dweilen of als u de bloemen water geeft). De vochtigheid kan in het meubelstuk dringen en het beschadigen.
PL	Mebel należy chronić przed wodą (np. podczas czyszczenia lub podlewania kwiatków). Wilgoć może wnikać w mebel i uszkodzić go.
TR	Genelde mobilyalarınızı sudan koruyunuz (örneğin, yerleri paspaslarken veya çiçekleri sularken). Nem, mobilya parçasına nüfuz edebilir ve zarar verebilir.
RU	Предохраняйте мебель от попадания воды (например, при вытирании или поливке цветов). Не допускайте попадания влаги на мебель, чтобы предотвратить ее повреждение.
D	Der Artikel ist kein Kinderspielzeug! Lassen Sie Kinder auch nicht mit der Verpackung spielen. Sie könnten an der Folie ersticken oder sich an der Umverpackung verletzen.
GB	This product is not a toy! Do not allow children to play with the packaging. They could suffocate in the foil or injure themselves on the packaging.
NL	Het artikel is geen speelgoed voor kinderen! Zorg ervoor dat kinderen ook niet met de verpakking spelen. Ze kunnen stikken door de folie of zich verwonden aan de verpakking.
PL	Produkt nie służy do zabawy! Dzieci nie powinny bawić się opakowaniem produktu, gdyż mogą się udusić folią lub skaleczyć opakowaniem.
TR	Bu ürün bir çocuk oyuncakı değildir! Çocukların ürün ambalajlarıyla oynamalarına asla müsaade etmeyiniz. Çocuklar, folyo nedeniyle boğulabilir veya ambalaj nedeniyle yaralanabilirler.
RU	Не допускается игра детей с изделием! Не разрешайте детям играть с упаковочным материалом. Дети могут задохнуться в упаковочной пленке или пораниться упаковочным материалом.

Service • Dienstverlening • Serwis • Servis • Сервисная служба

Name • Naam • Nazwa • Isim • Название	
Nr • No. • Номер	
Typ • Type • Тип • Тип	
☺	

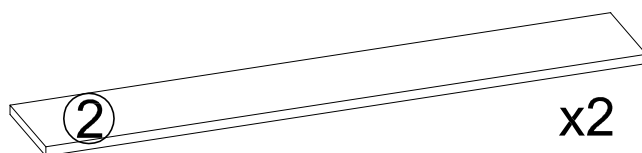
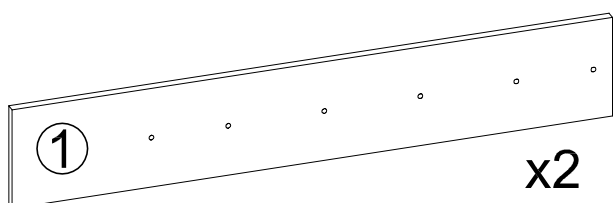

1

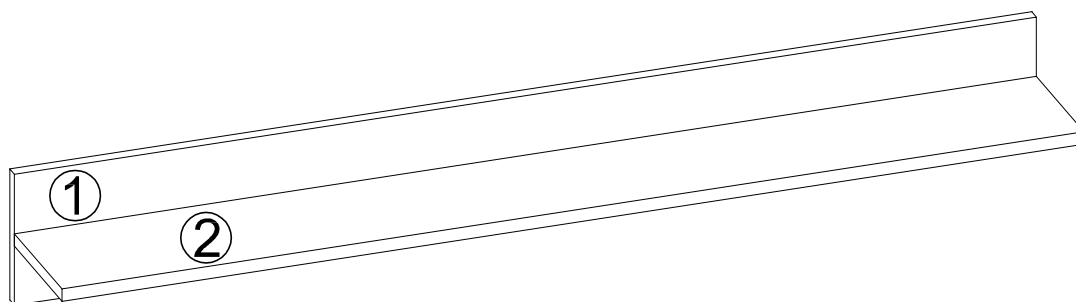

2

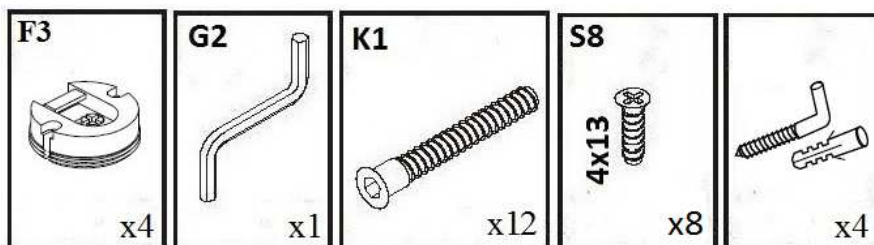
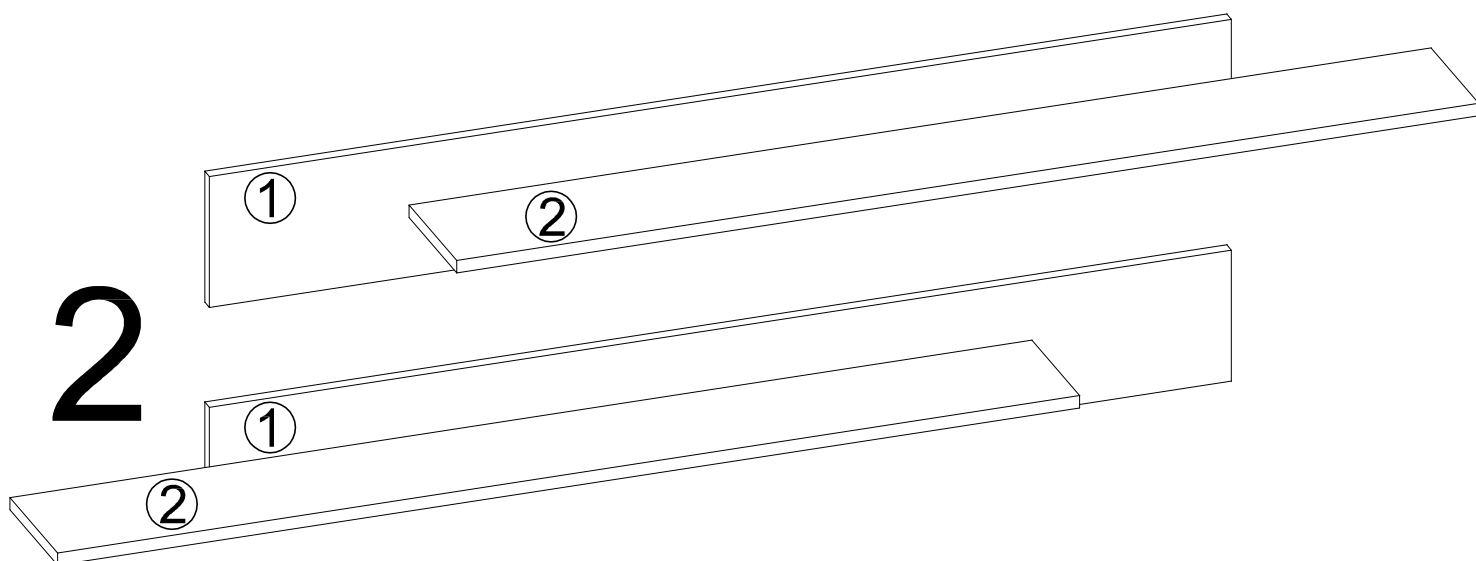

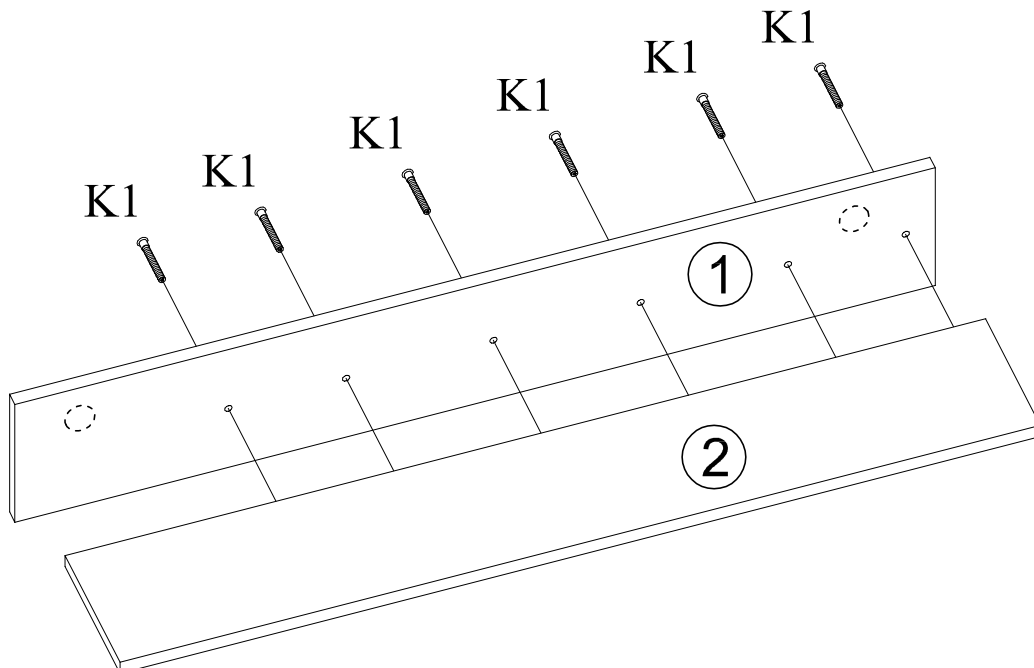
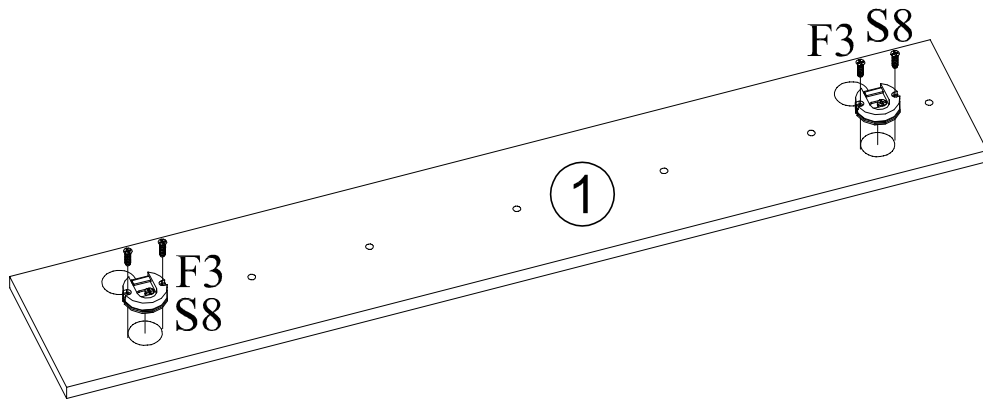
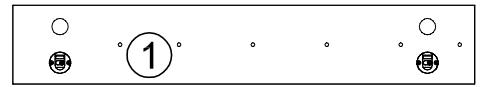
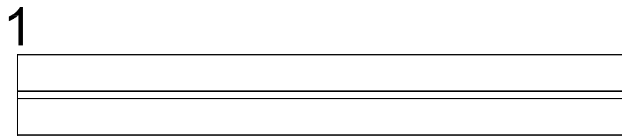
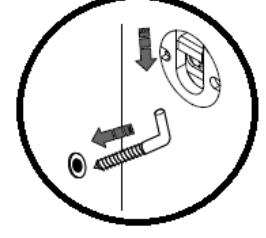
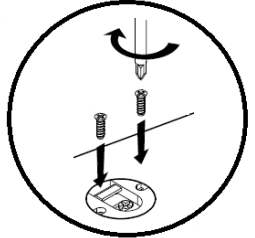
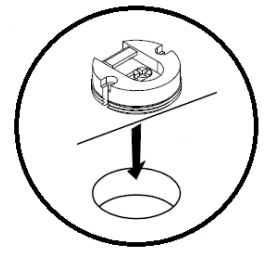
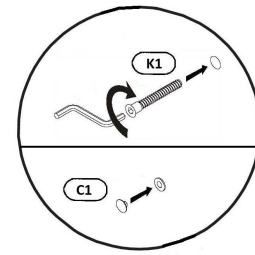
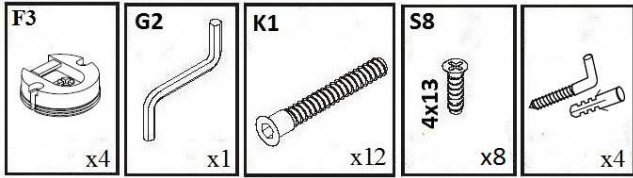
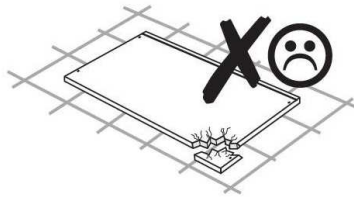
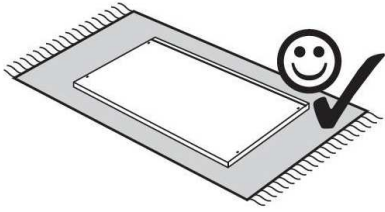

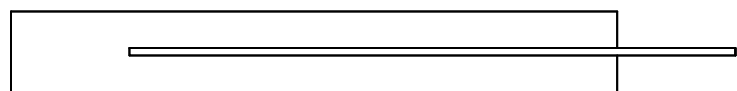
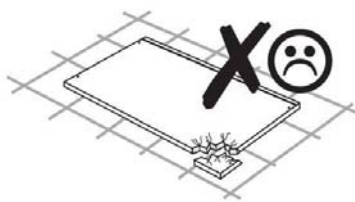
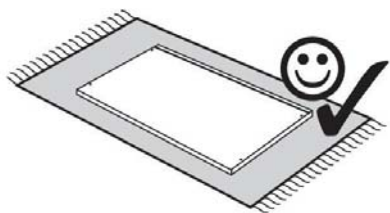

2

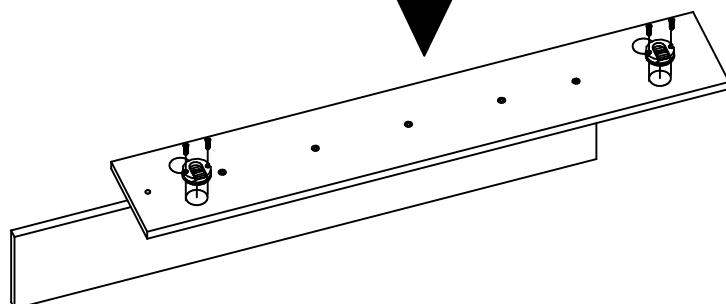
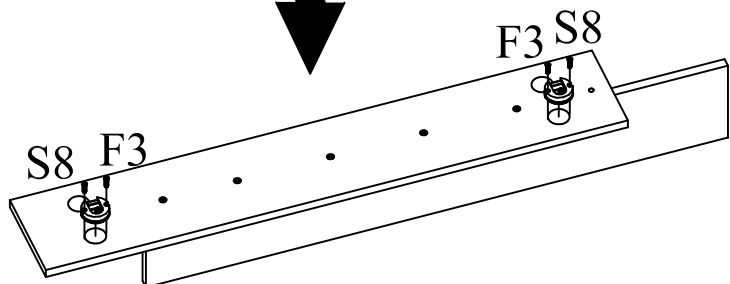
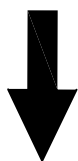
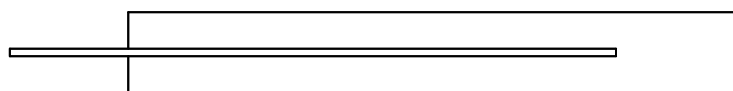
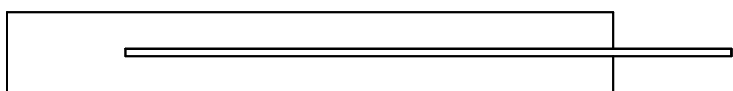
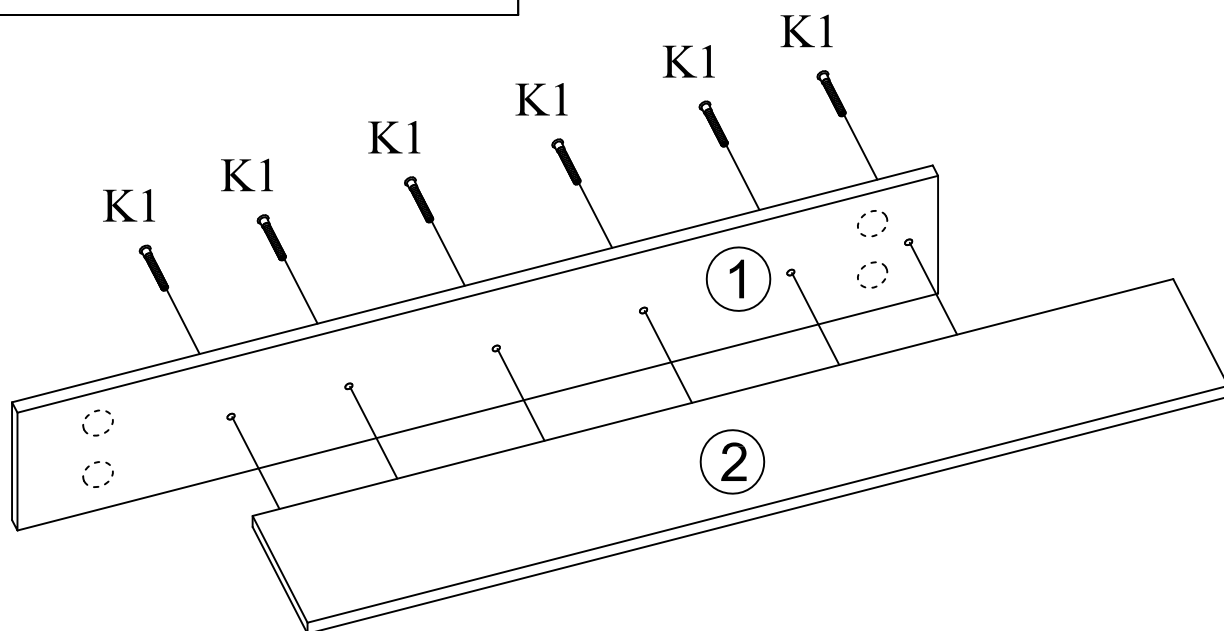
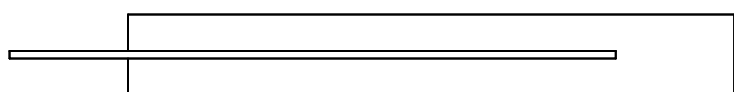
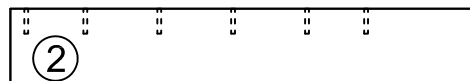
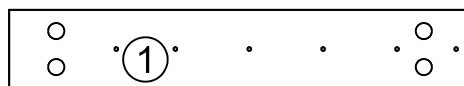

Modellname: **FLY**
Nazwa modelu:

Modellreihe: **23 -- FL**
Numer modelu:

21

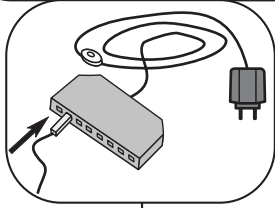
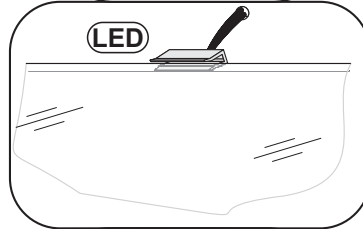
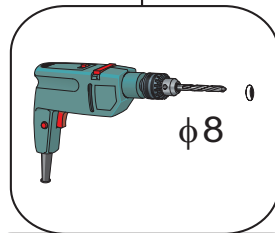
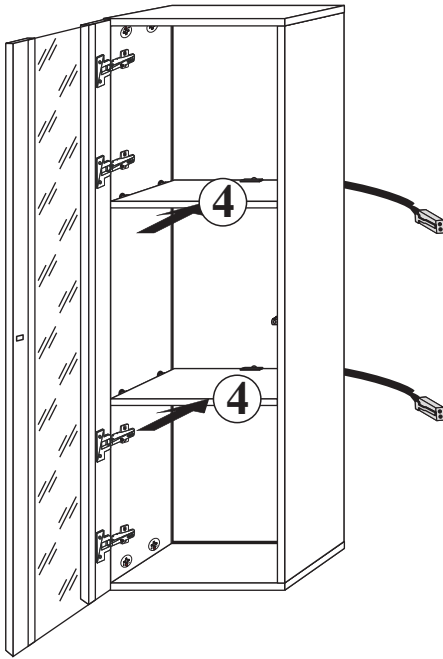

22

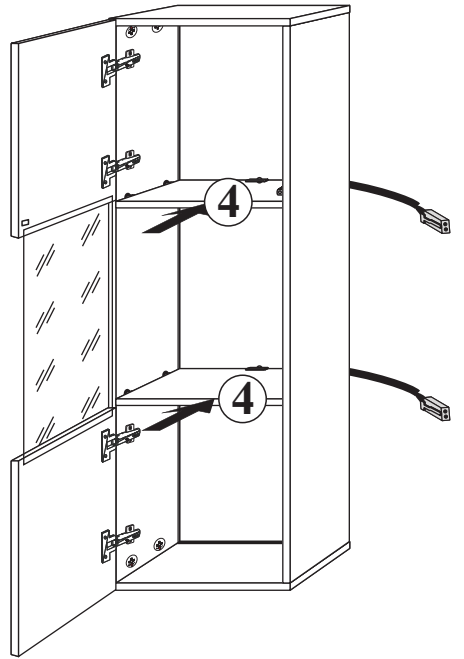

41

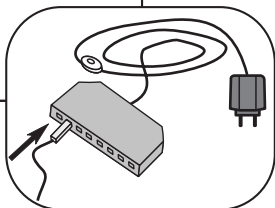
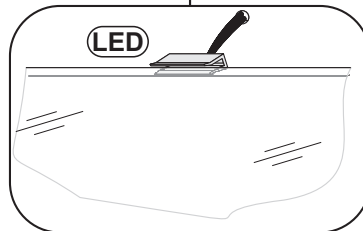
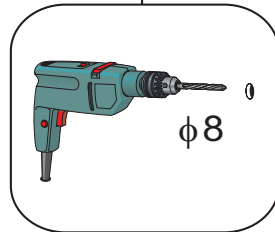
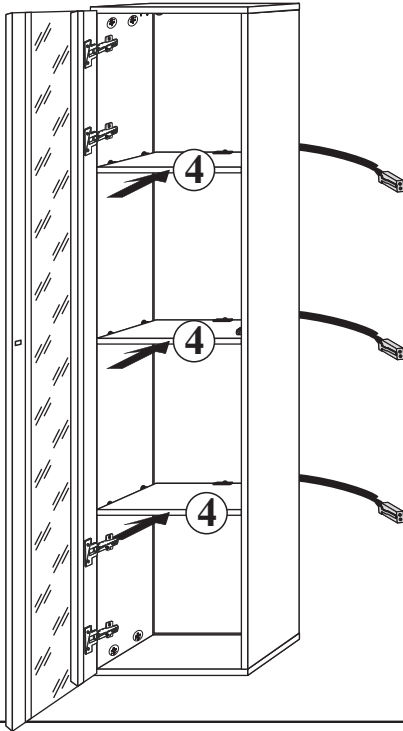

42

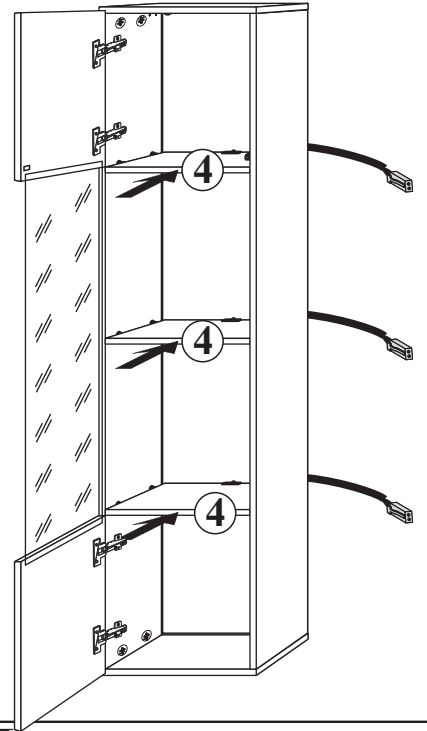

SBI

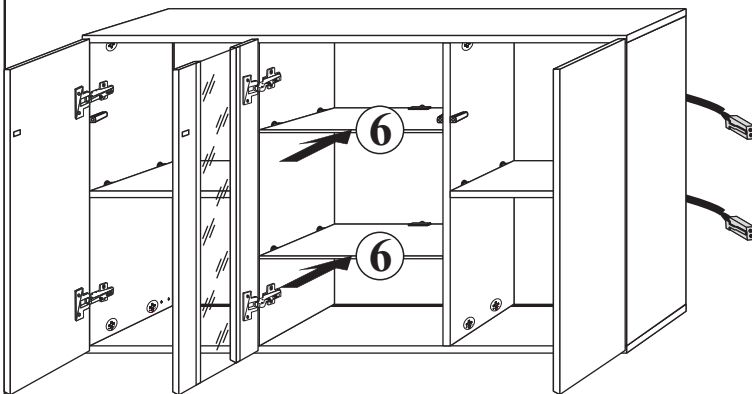

SBII

