

## F183-FRN/183

A	B	C	D
1	F24-001	925	710 1/1

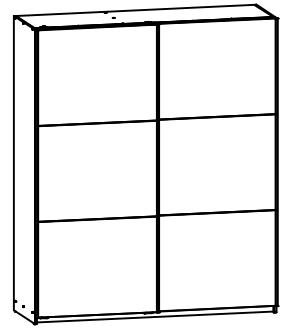

## F183-FRN/183-LUS

A	B	C	D
2	F24-006	925	710 1/1

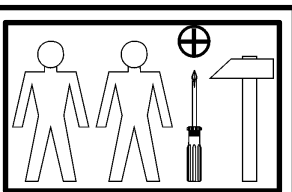
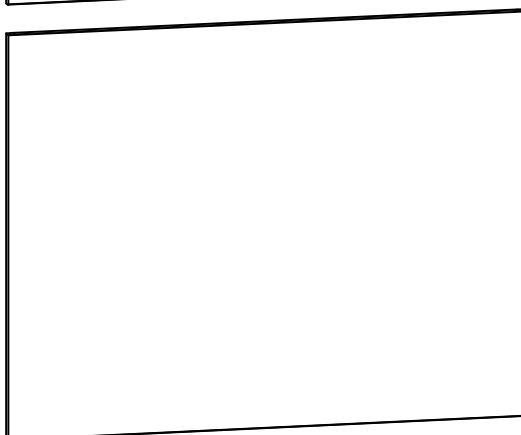
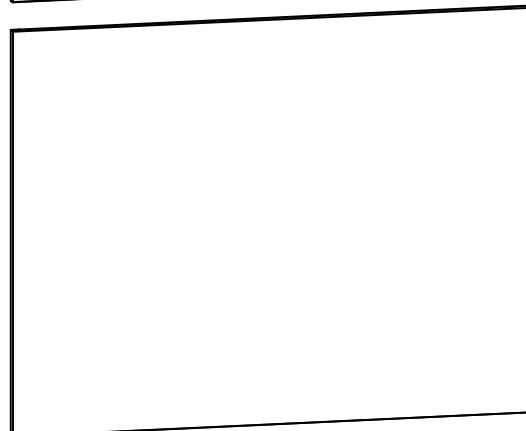
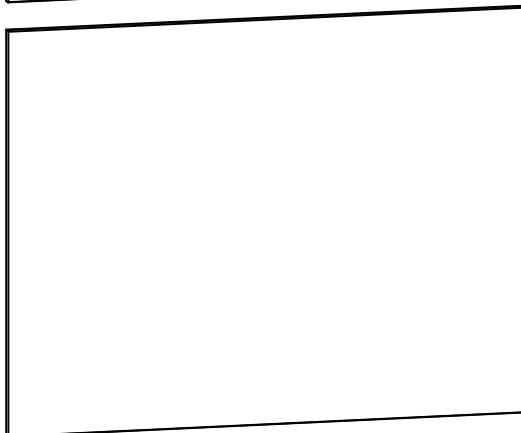
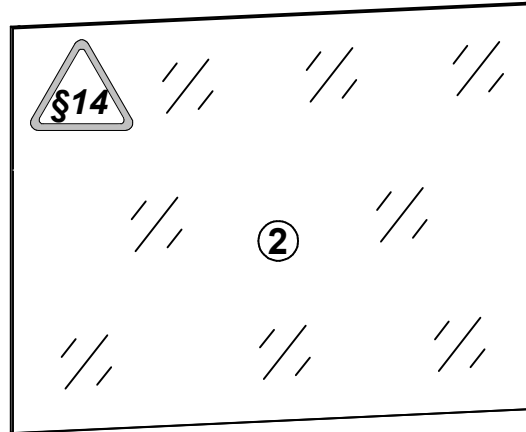
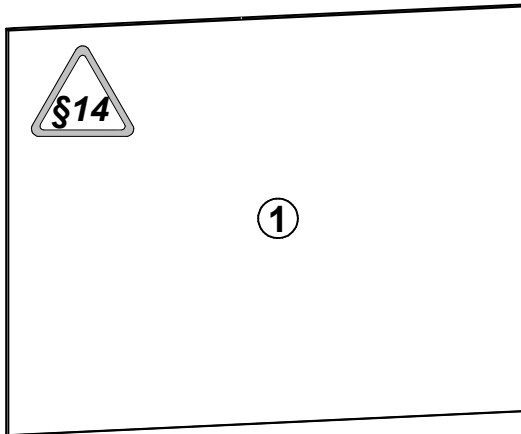

1 §2

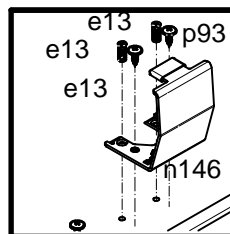
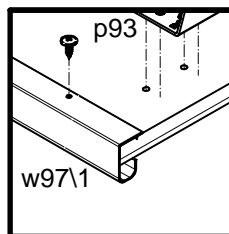
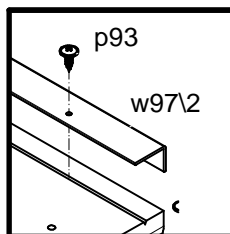
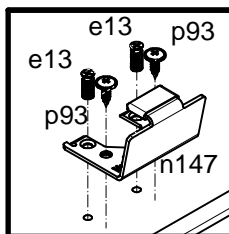
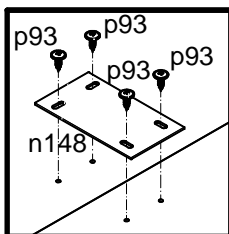
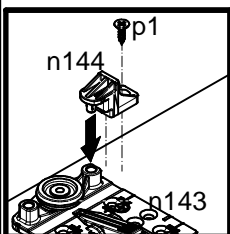
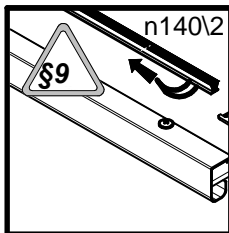
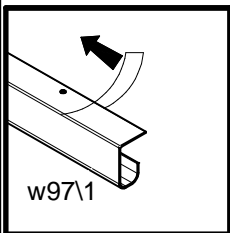
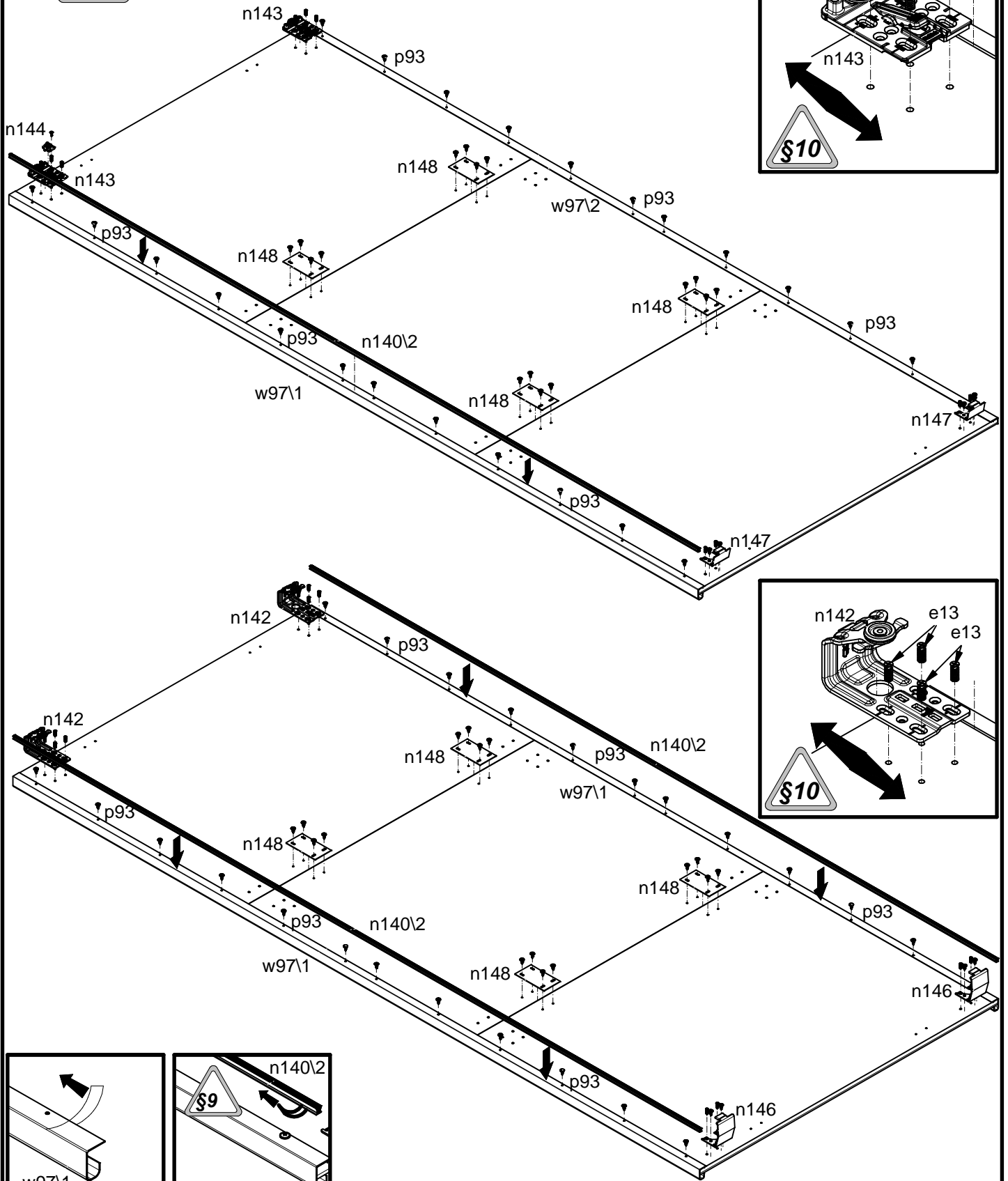

# 2

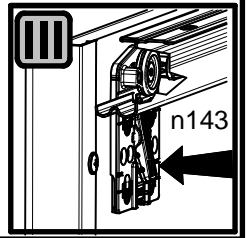
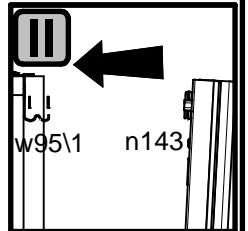
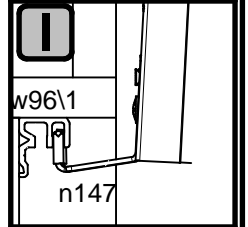
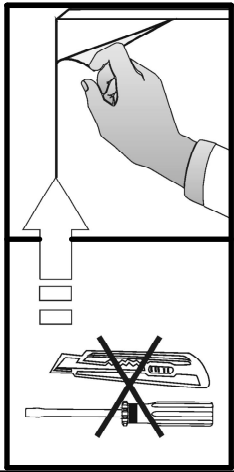
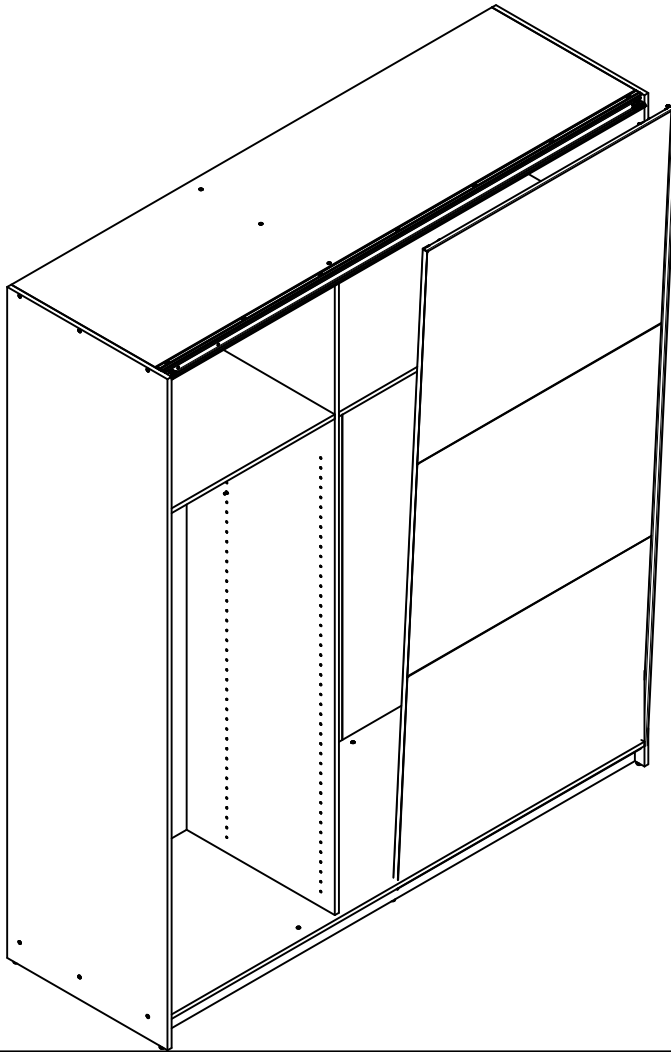

# 3

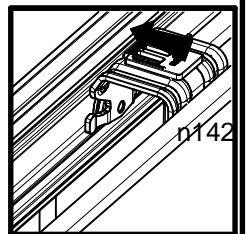
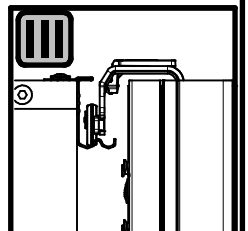
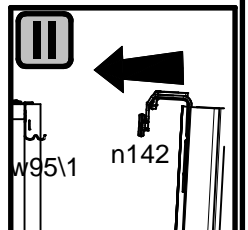
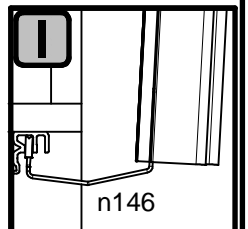
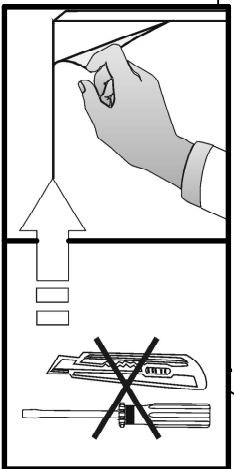
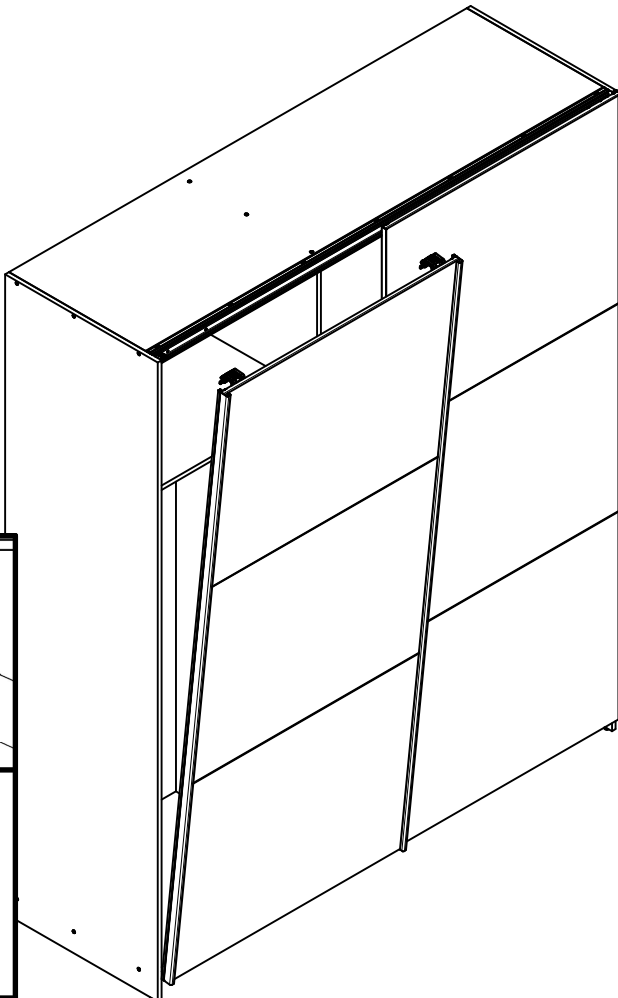

# F24

# Opcja półki

A	B	C	D
1	F24-305	657	555 1/1
2	F24-312	657	555 1/1

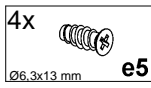
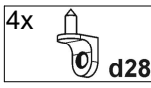
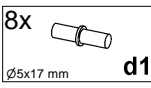
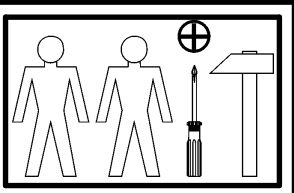
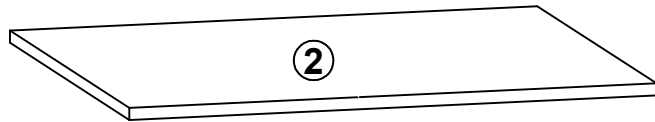
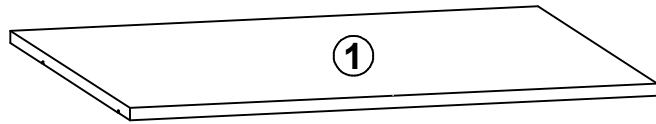

1

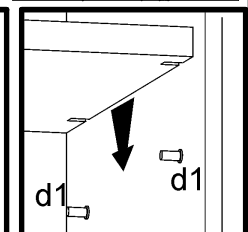
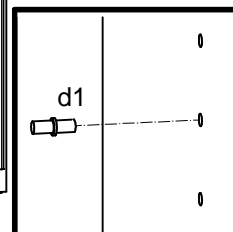
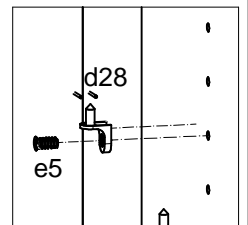
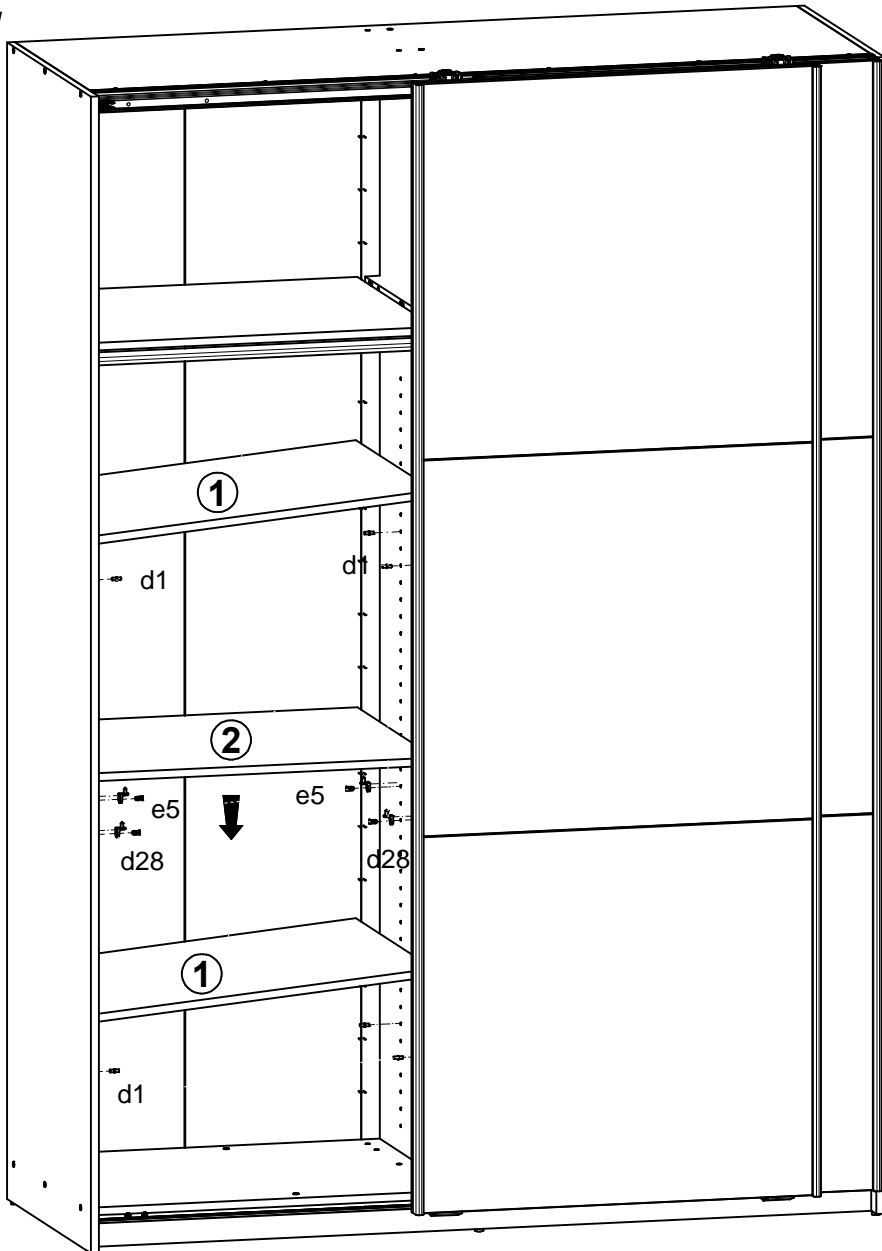

# F24

# F24-SZF/183

A	B	C	D	A	B	C	D		
1	F24-101	2180	600	1/4	9	F24-404	1800	66	1/4
2	F24-102	2180	571	1/4	10	F24-901	2109	677	1/4
3	F24-103	2084	555	1/4	11	F24-903	2109	1149	1/4
4	F24-303	657	555	2/4	12	dr-1123	1123	30	2/4
5	F24-306	1800	571	2/4	13	dr-652	652	22	2/4
6	F24-307	1800	555	2/4					
7	F24-308	1128	555	2/4					
8	F24-403	1800	66	1/4					

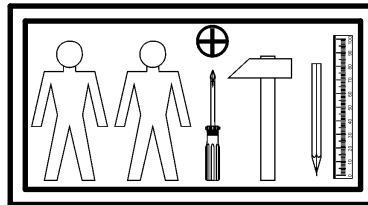
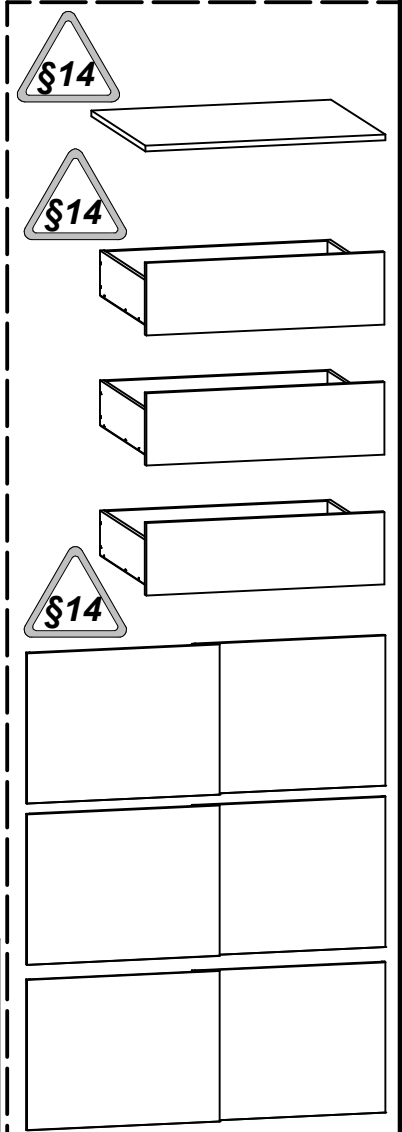
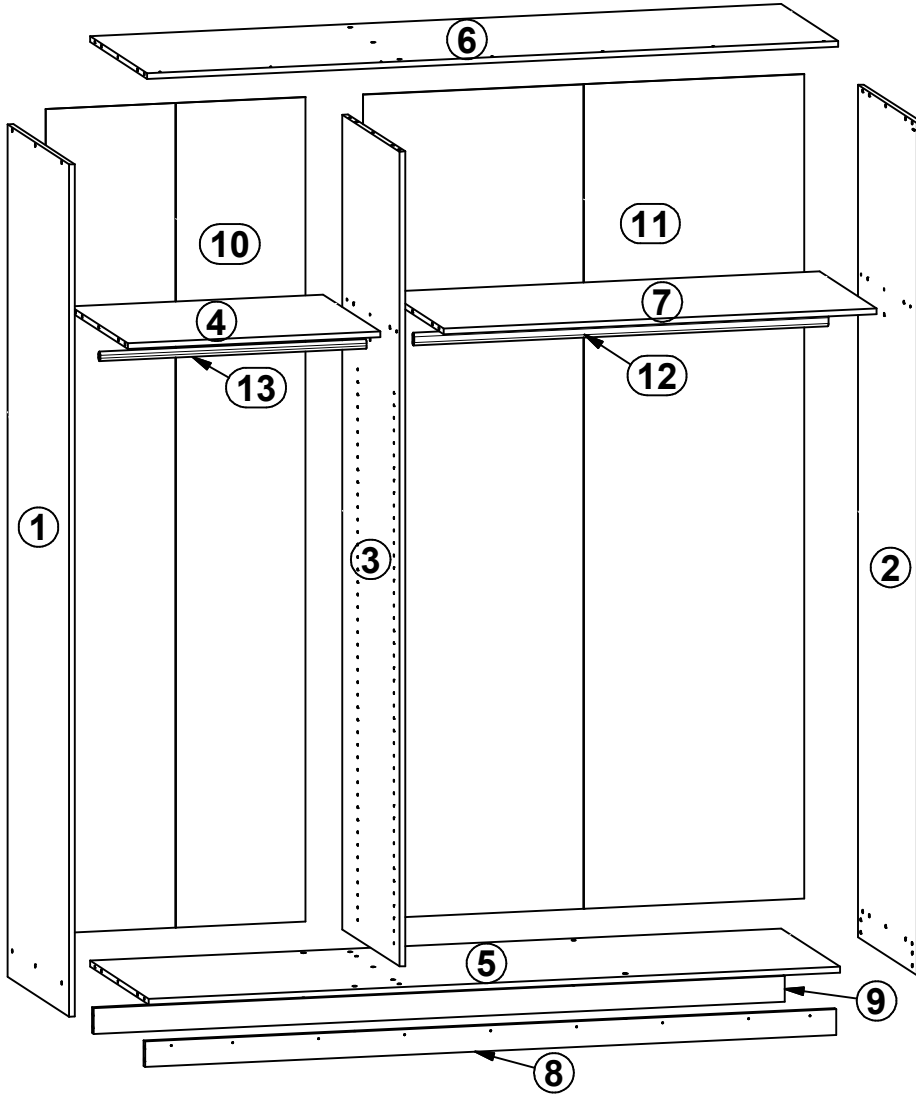
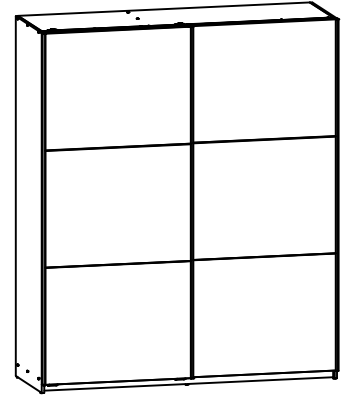

1x z1	22x φ7x50 mm e1	24x φ5,5x13 mm e13	28x φ8x30 mm f1	2x f20	6x k1	140x l1	4x n158	3x n140\2
2x n142	2x n143	1x n144	2x n145	2x n146	2x n147	8x n148	14x φ3,5x13 mm p1	4x φ3,5x25 mm p16
2x φ4x22 mm p60	95x φ4x13 mm p93	12x φ15x12mm #16 r1	12x r42	1x w95\2	1x w96\2	3x w97\1	1x w97\2	16x s1
12x ø16 s2								

# 1

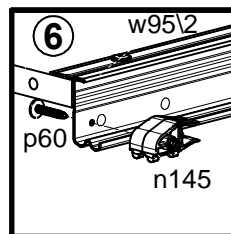
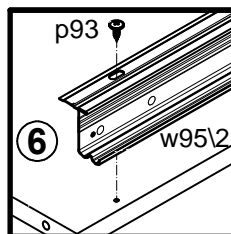
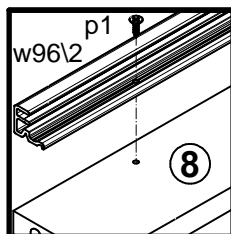
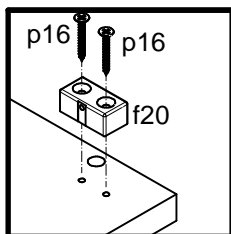
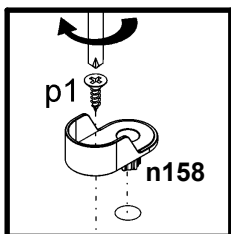
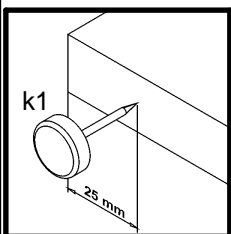
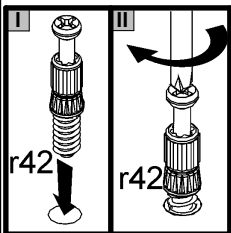
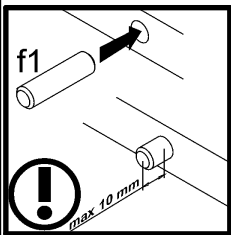
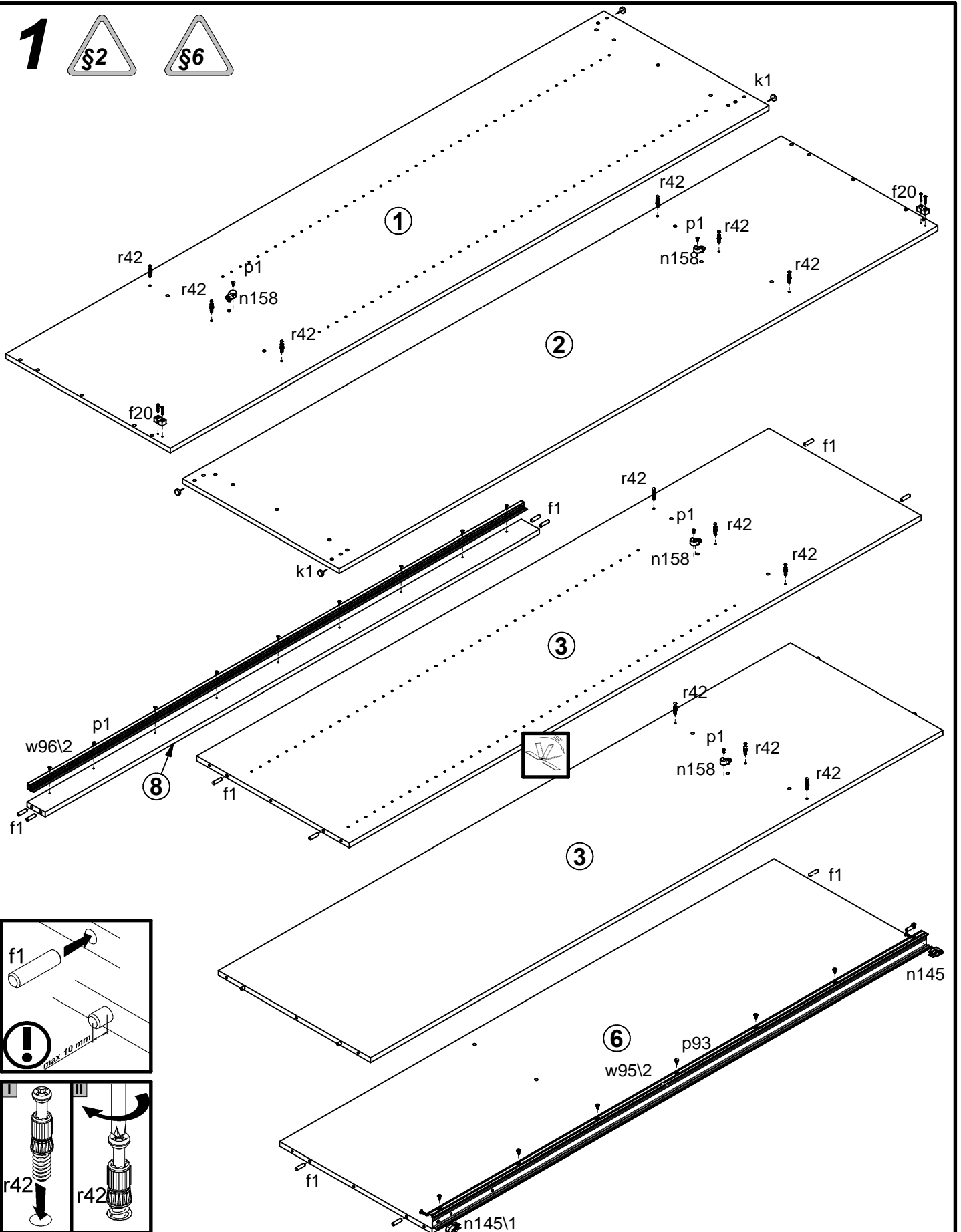

# 2

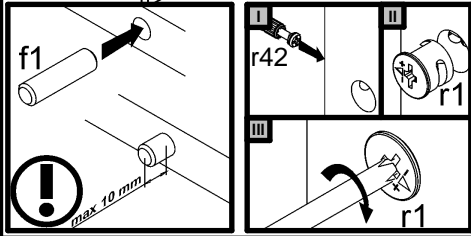
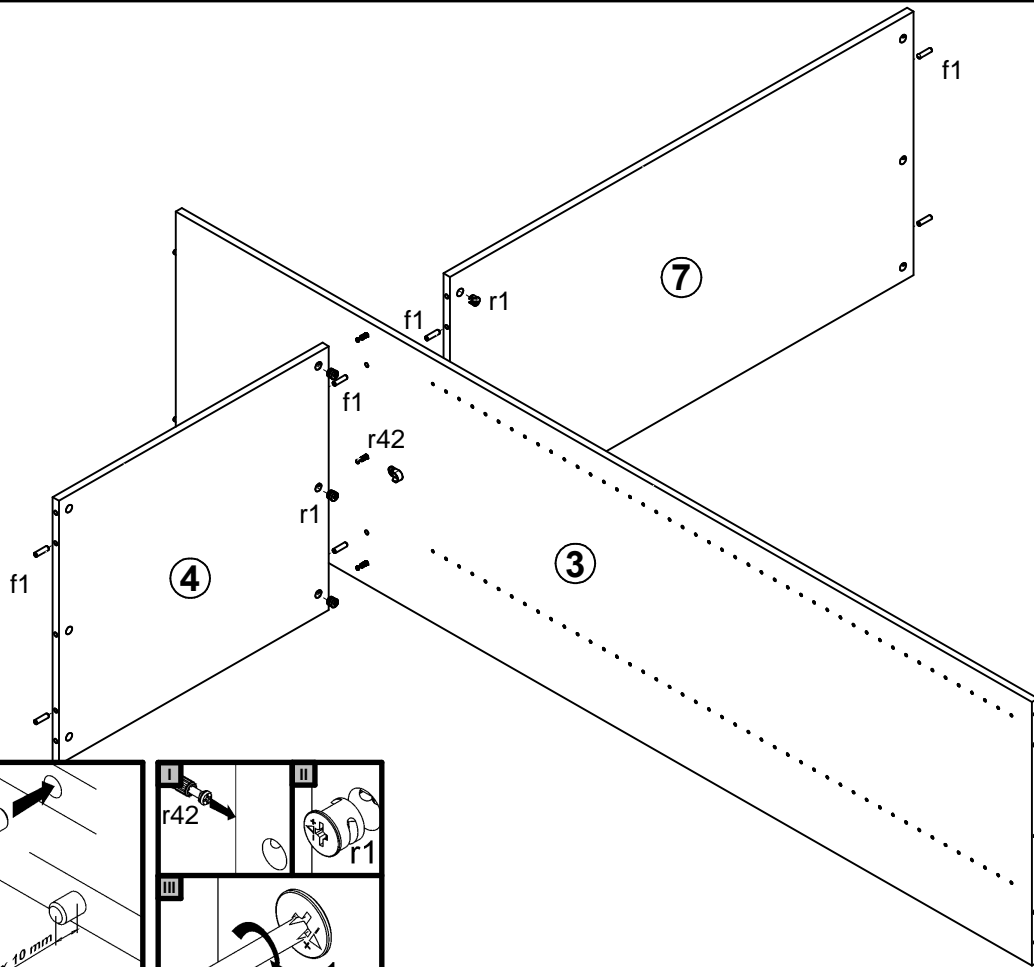

# 3

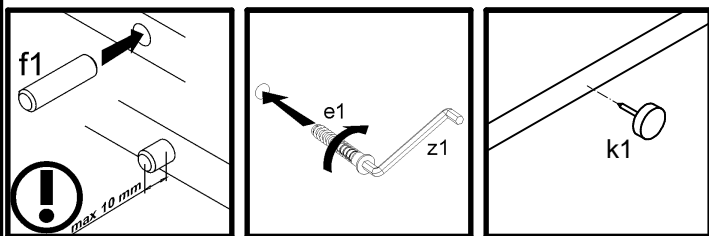
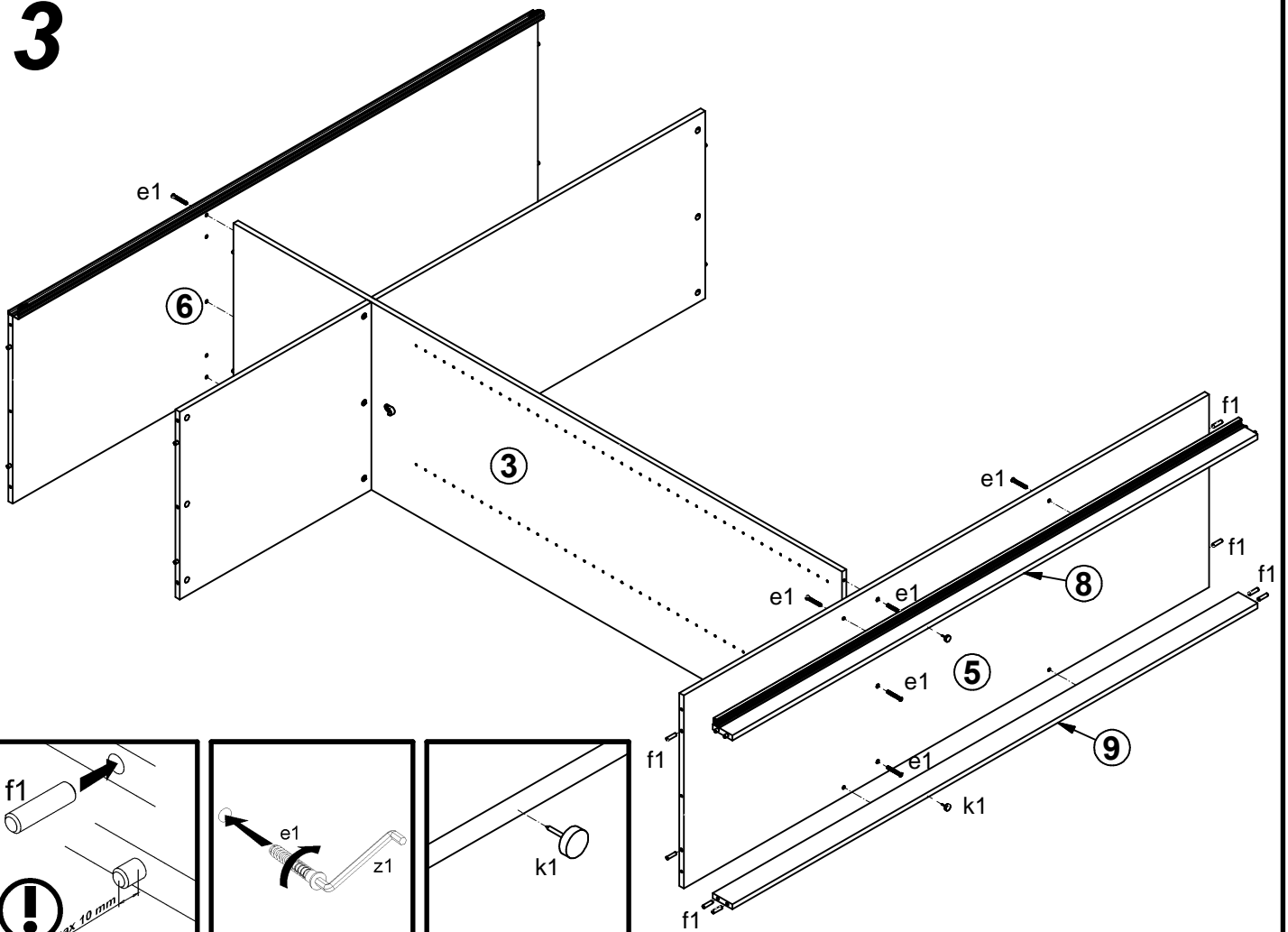

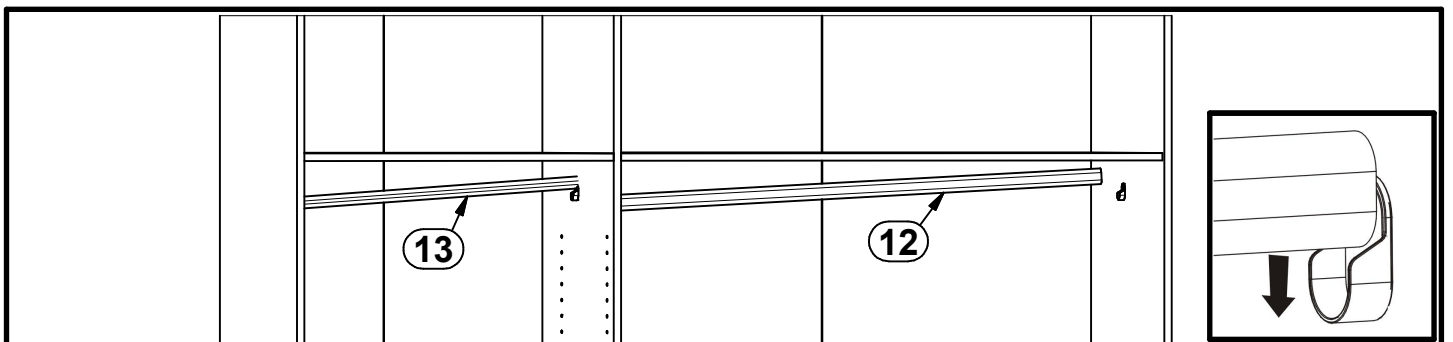
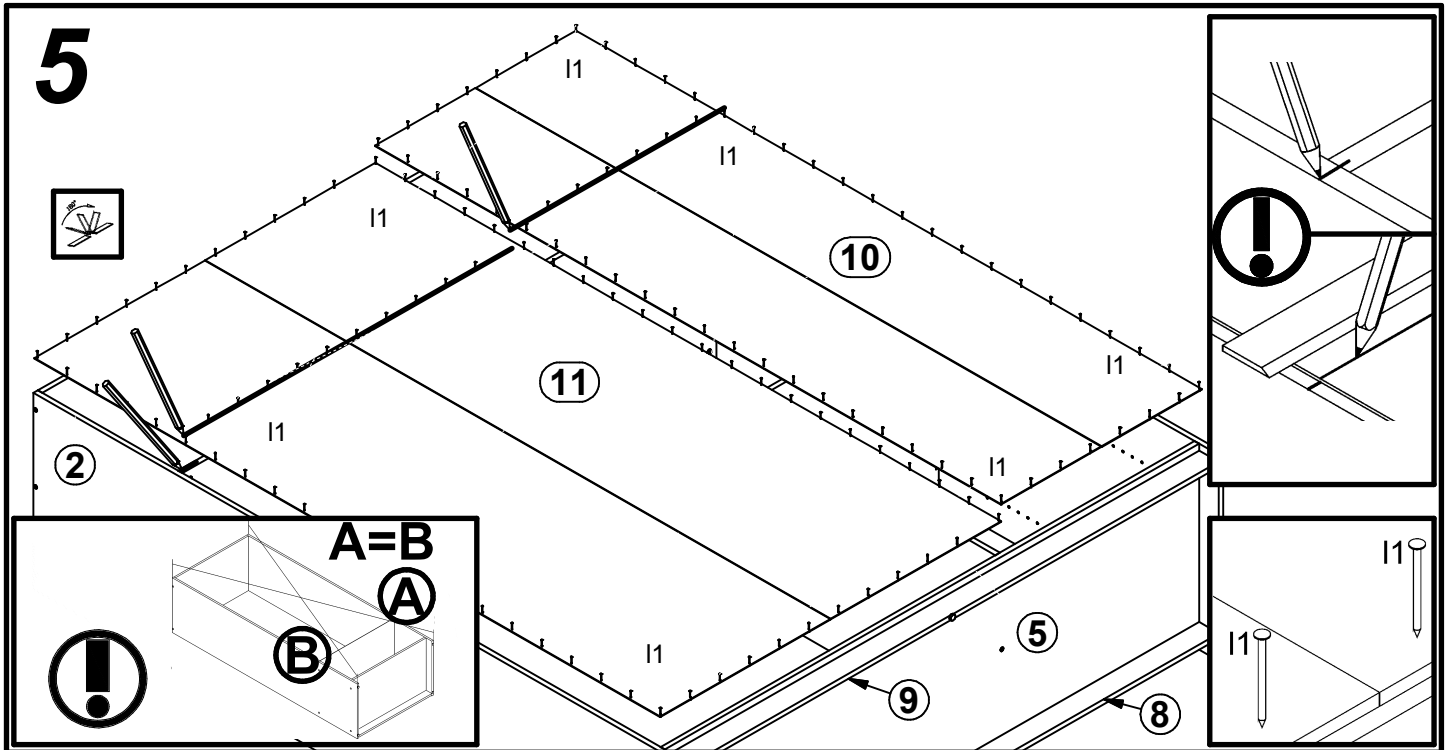
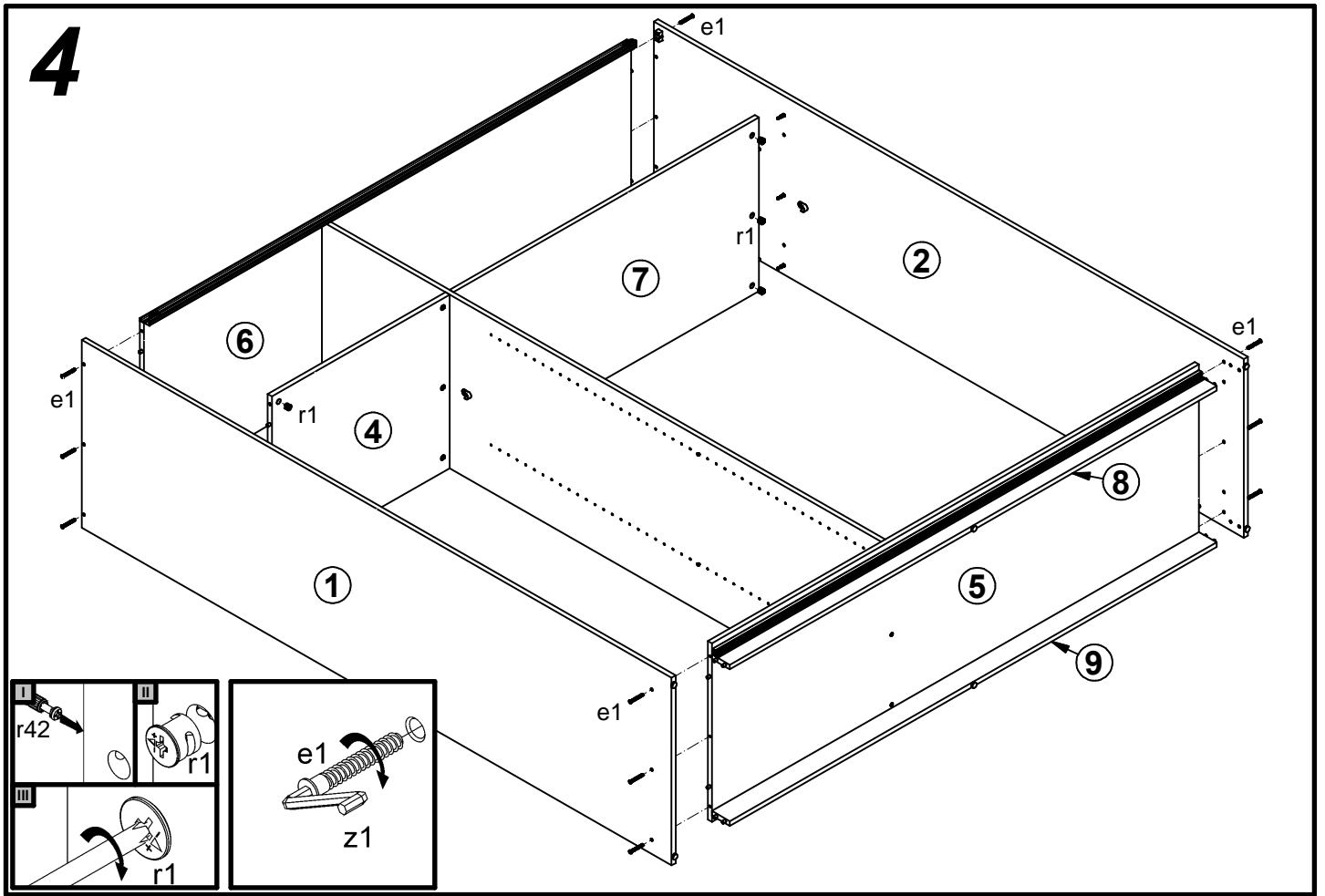



# F24

# Opcja szuflada

A	B	C		D
1	F24-004	652	195	1/1
2	F24-312	657	555	1/1
3	F24-905	503	630	1/1
4	ZS3-505	500	120	1/1
5	ZS3-506	500	120	1/1
6	ZS3-5553	608	120	1/1

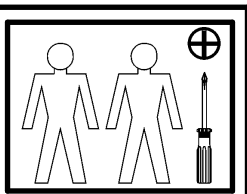
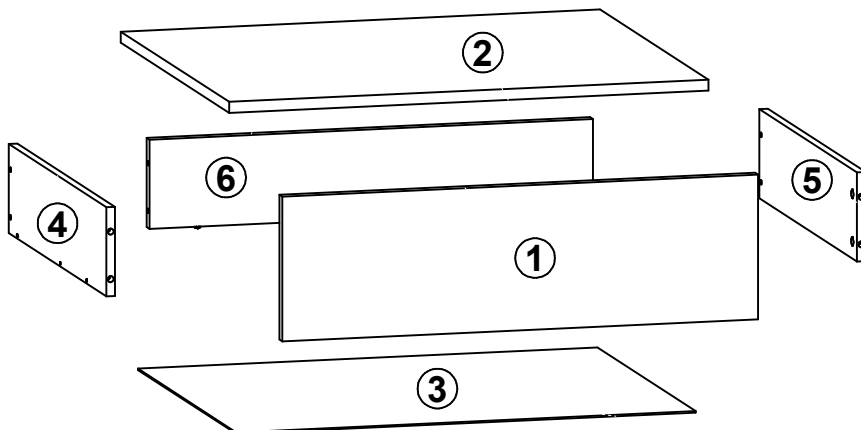

4x d28	18x e19 Ø5x9 mm	16x e3 Ø6x13 mm	12x f25 Ø6.5x40 mm	12x p38 Ø3.5x16 mm	12x r15 Ø12x10.5 mm #12	12x r42	3x 500 mm w26\CL	3x 500 mm w26\CR
3x 500 mm w26\DL	3x 500 mm w26\DR							

