

A	B	C	D
1	S321-011	1196	400 2/2
2	S321-124	384	355 1/2
3	S321-125	384	355 1/2
4	S321-126	353	255 1/2
5	S321-203	1200	355 1/2
6	S321-327	1167	354 1/2
7	S321-913	1177	363 2/2

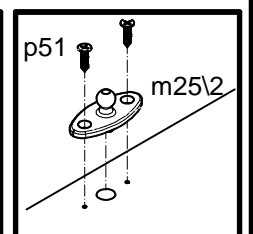

2

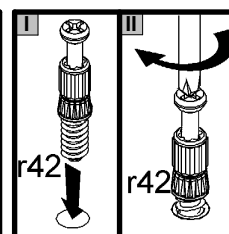
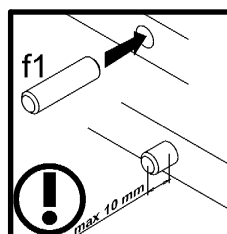
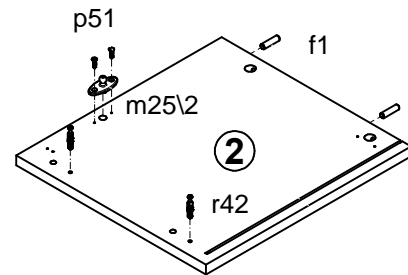
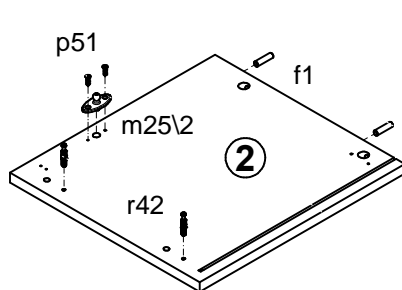
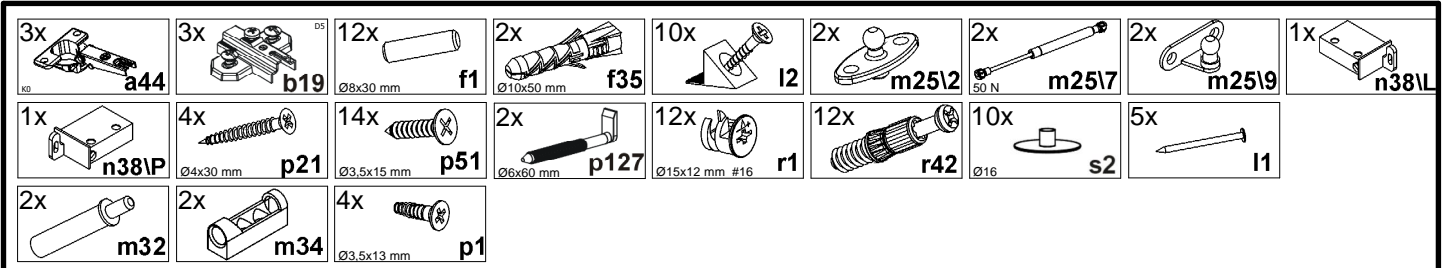
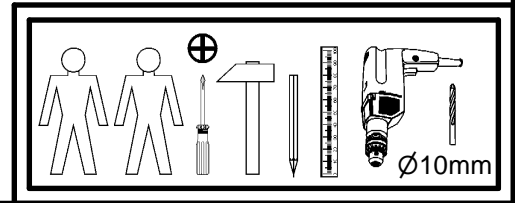
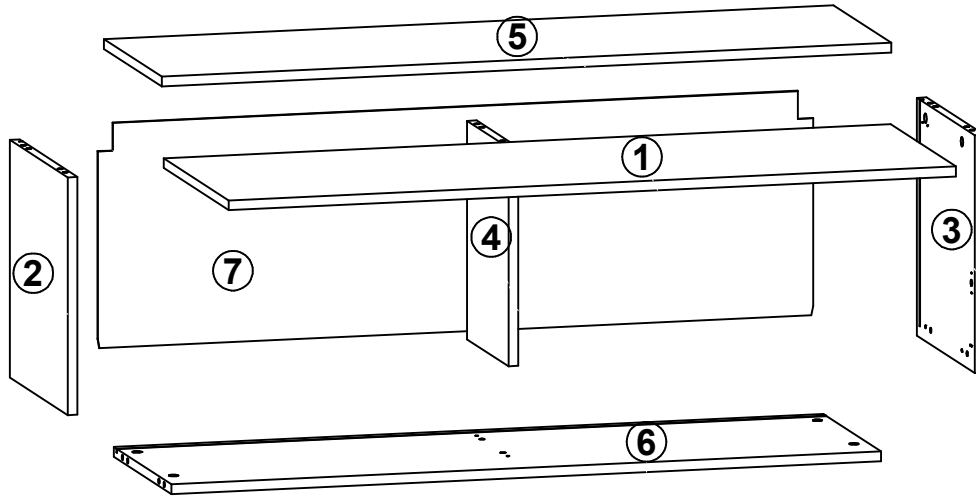
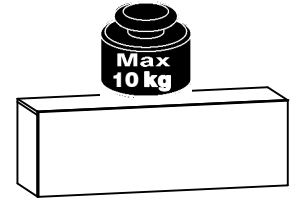
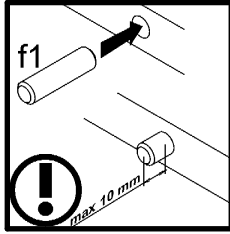
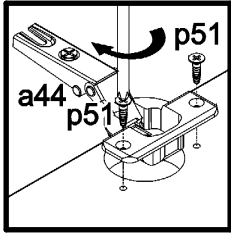
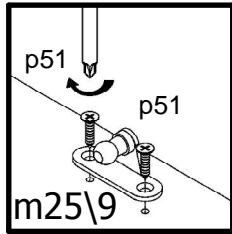
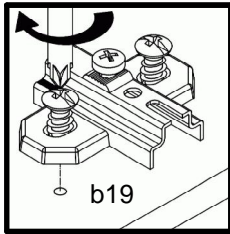
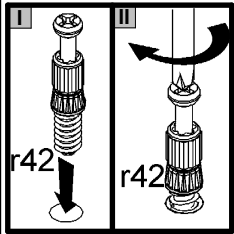
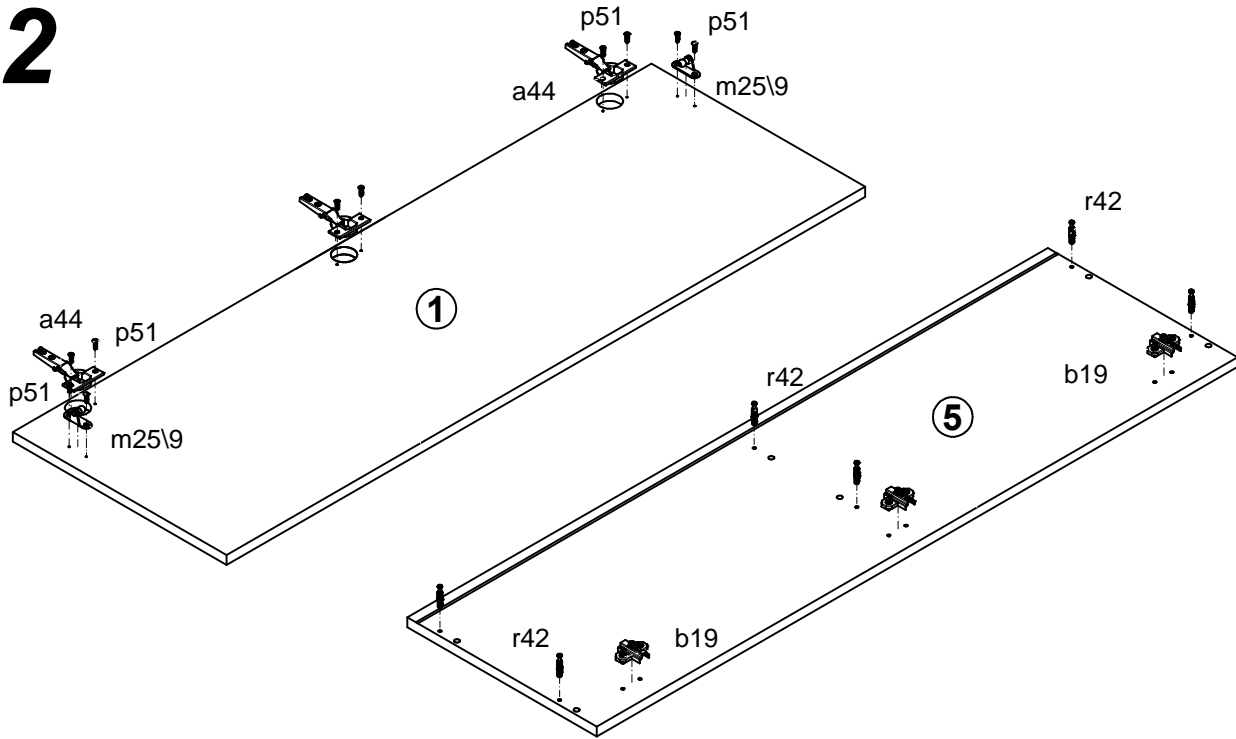

3

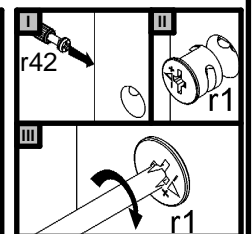
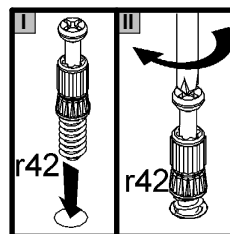
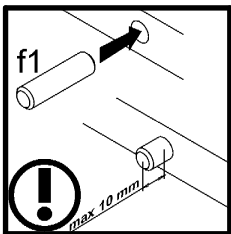
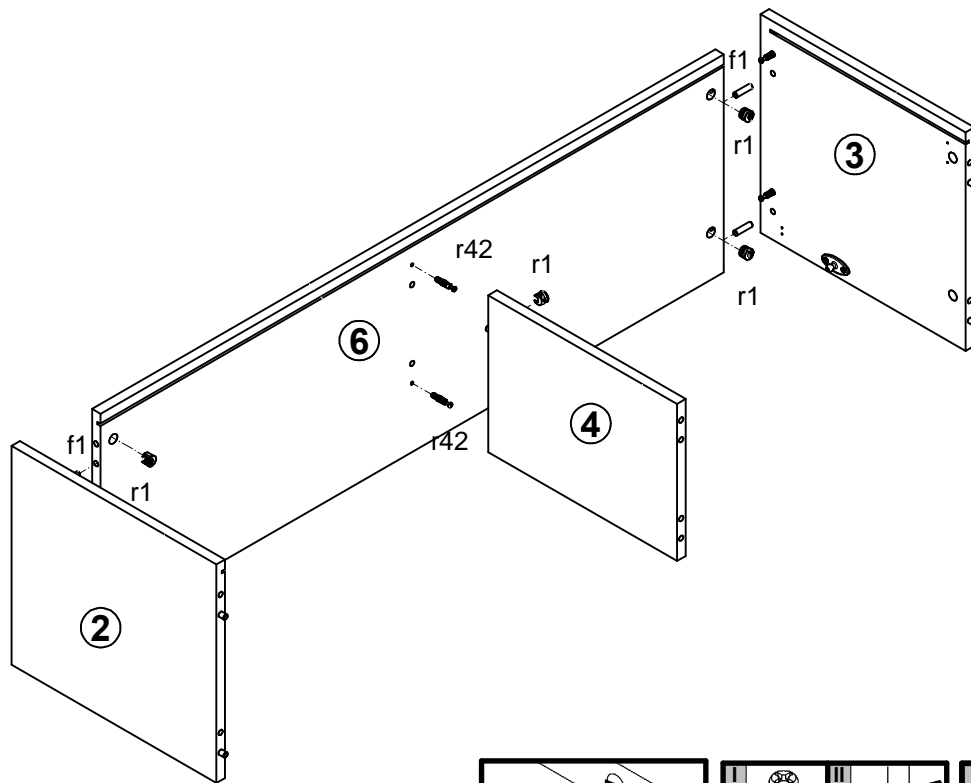

4

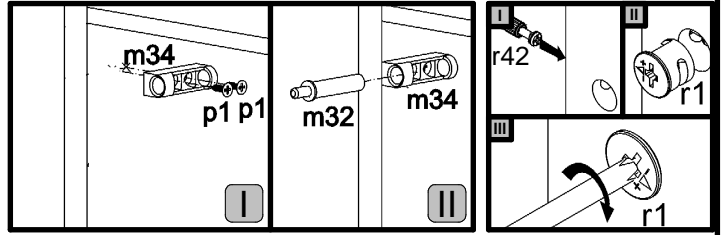
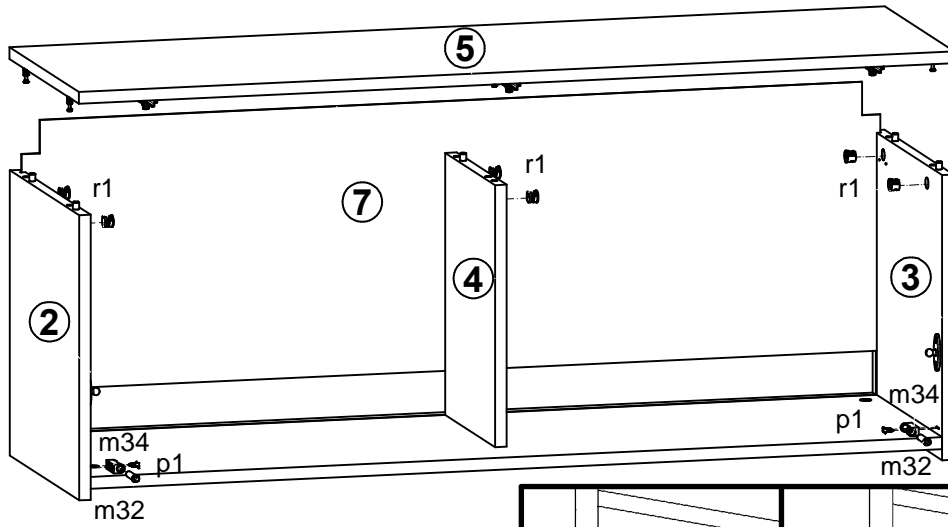

5

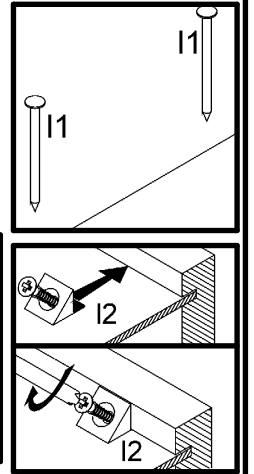
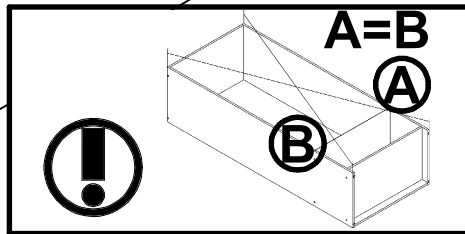
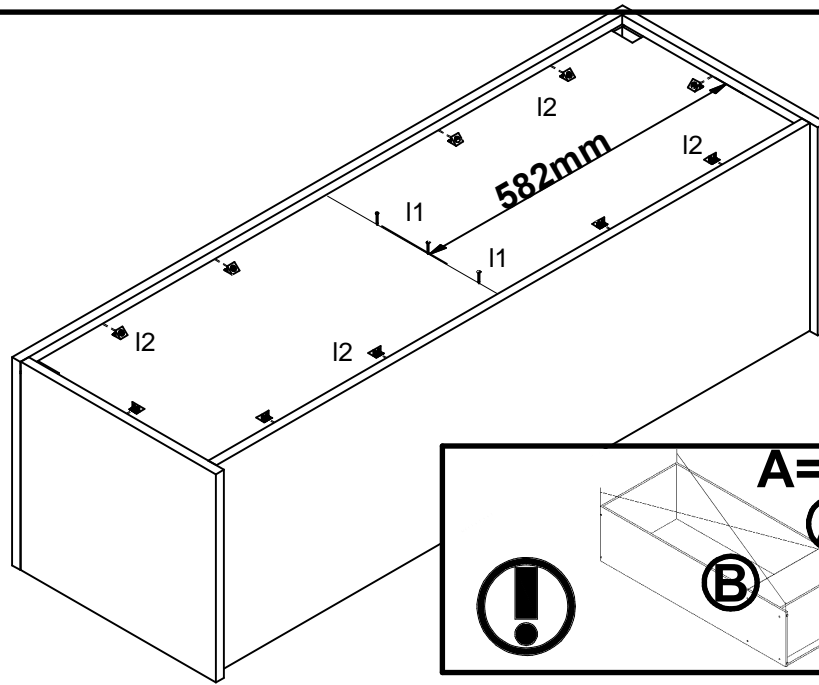

6

