

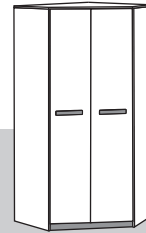

www.MLMEBLE.pl



GB assembly instructions / D montageanleitung / CZ montážní návod / SK montážny návod / RU инструкции по монтажу / LT surinkimo instrukcija



INSTRUKCJA MONTAŻU

BEST 01

199 92 92

akcesoria / accessories / zubehör / příslušenství / prislušenstvo / аксессуары / furnitūra :

x 22 KK 8/32	x 17 KT 6,3/50	x 8 ZA N	x 100 GZ 1,4/25	x 8 SG 8/8	x 17 MD	x 11 ZAM	x 4 UB 0	x 24 PA Ø5	x 30 WT 3,5x16	x 4 WT 4x30
x 6 ZA 45°	x 6 PK H-4	x 12 WE 6,3x30	x 2 PO Ø5 E	x 24 BDP	x 6 DPP 03	x 2 drażek / stick / stock / hůl / palica / трость / strypas	x 1 LT	x 2 UT 1.839	x 1 klej / glue / kleber / lepidlo / lepidlo / клей / kljaj	x 1 kluczyk / key / schlüssel / klíč / ключ / raktas

do montażu potrzebne są:

are needed for assembly:
sind erforderlich für die montage:
jsou potřebné pro montáž:
sú potrebné pre montáž:
сú потрібні для сборки:
Surinkimui reikės:

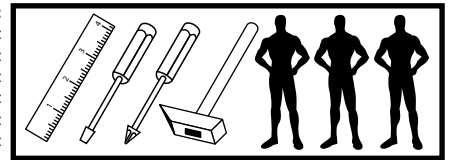

UWAGA ! - W pierwszej kolejności wbijamy akcesoria „KK” i „MD” w blaty oraz boki i montujemy prowadnice.

WARNING! - In the first place should be driven accessories "KK" and "MD" in the tops and sides and guides.

WARNUNG! - In erster Linie sollte Accessoires "KK" und "MD" in den Wipfeln und an den Seiten und Guides gefahren werden.

POZOR! - V první řadě by měl být tažen příslušenství "KK" a "MD" v korunách a po stranách a průvodců.

POZOR! - V prvom rade by mal byť ťahaný príslušenstvo "KK" a "MD" v korunách a po stranách a sprievodcov.

ВНИМАНИЕ! - В первую очередь следует руководствоваться аксессуарами "KK" и "MD", на вершинах и по бокам и руководства.

DĚMESIO! - Pirmiausiai furnitūrą KK ir MD įkalame į stalviršį ir šonus ir prisukame bėgelius.

UWAGA ! - w pierwszej kolejności wbijamy akcesoria „KK” i „MD” w blaty oraz boki.

WARNING! - The first accessory sticks "KK" and "MD" in the tops and sides.

WARNUNG! - Die erste Accessoire-Sticks "KK" und "MD" in den Spitzen und an den Seiten.

POZOR! - První příslušenství holí "KK" a "MD" v korunách a boky.

POZOR! - Prvé príslušenstvo palic "KK" a "MD" v korunách a boky.

ВНИМАНИЕ! - Первый аксессуаров палочки "KK" и "MD" по вершинам и по бокам.

DĚMESIO! - Pirmiausiai furnitūrą KK ir MD įkalame į stalviršį ir šonus.

Nr/No	Szt/Qty
1	1
2	2
3	1
4	2
5	1
6	1
7	1
8	1
9	1
10	1
11	3
12	1
13	3
14	1
15	2
16	2
17	2
18	1

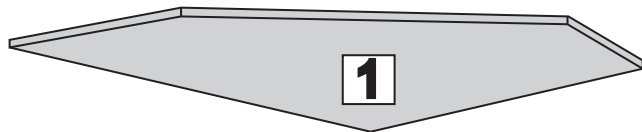

2

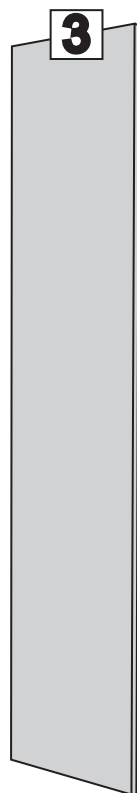

4

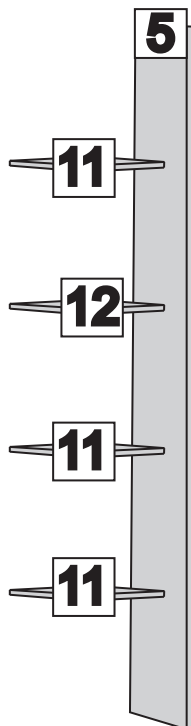

5

11

12

11

11

10

6

7

13

14

13

13

4

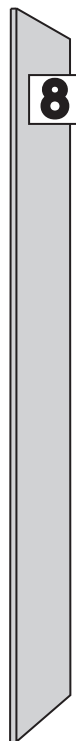

8

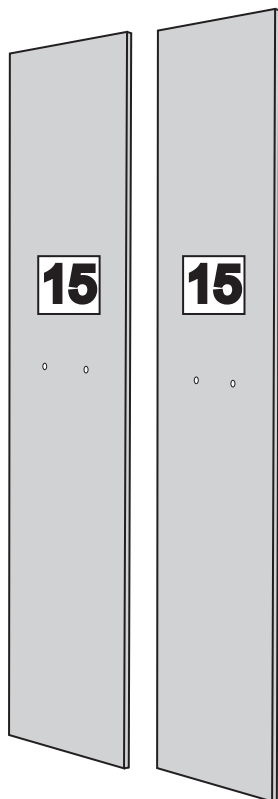

15

15

2

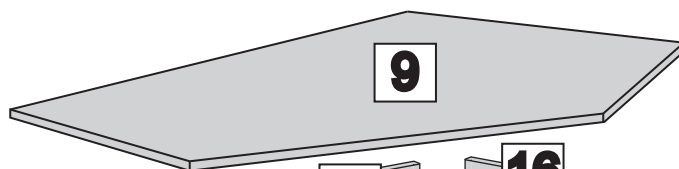

9



16



16



17



17



18

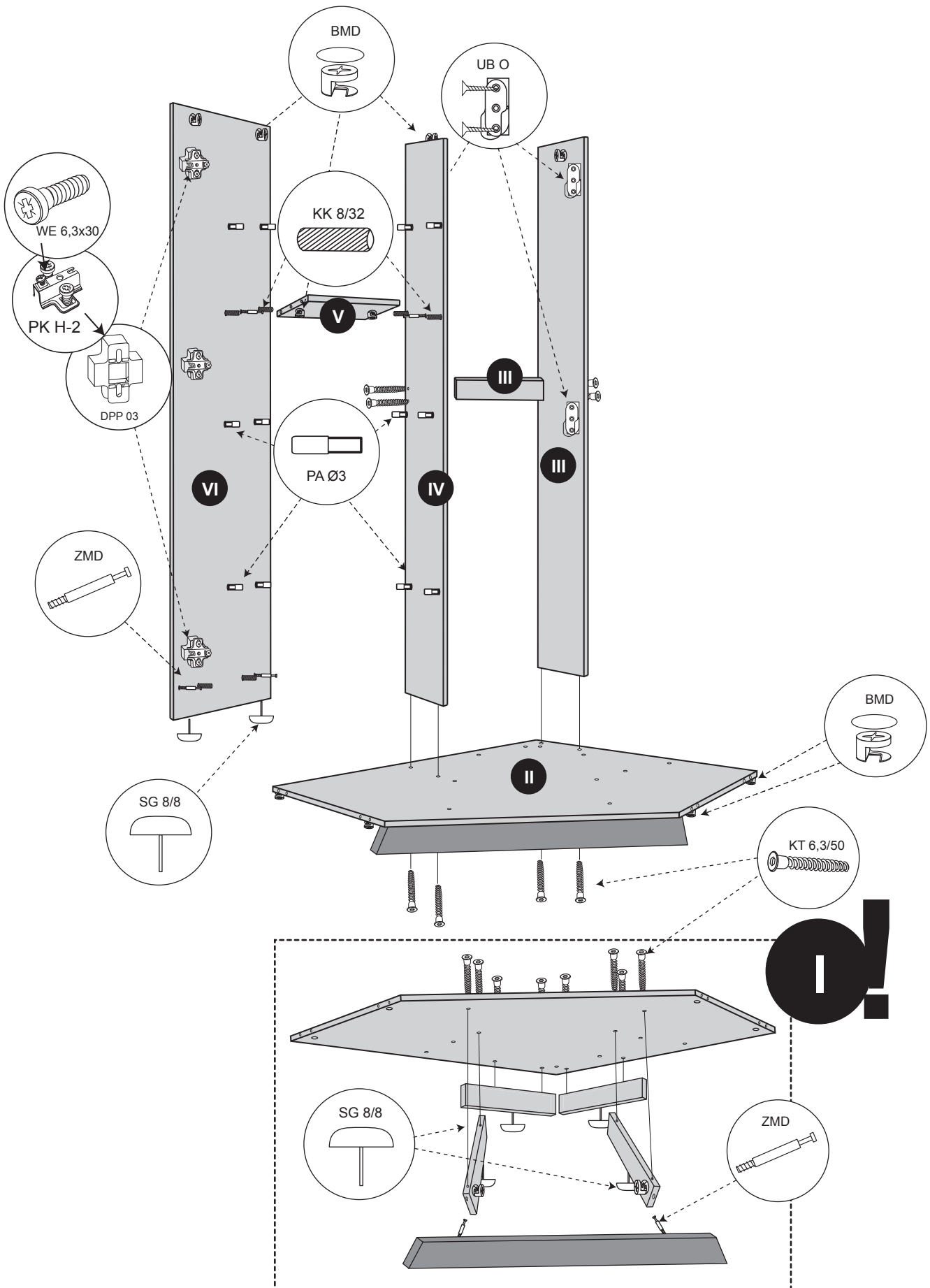

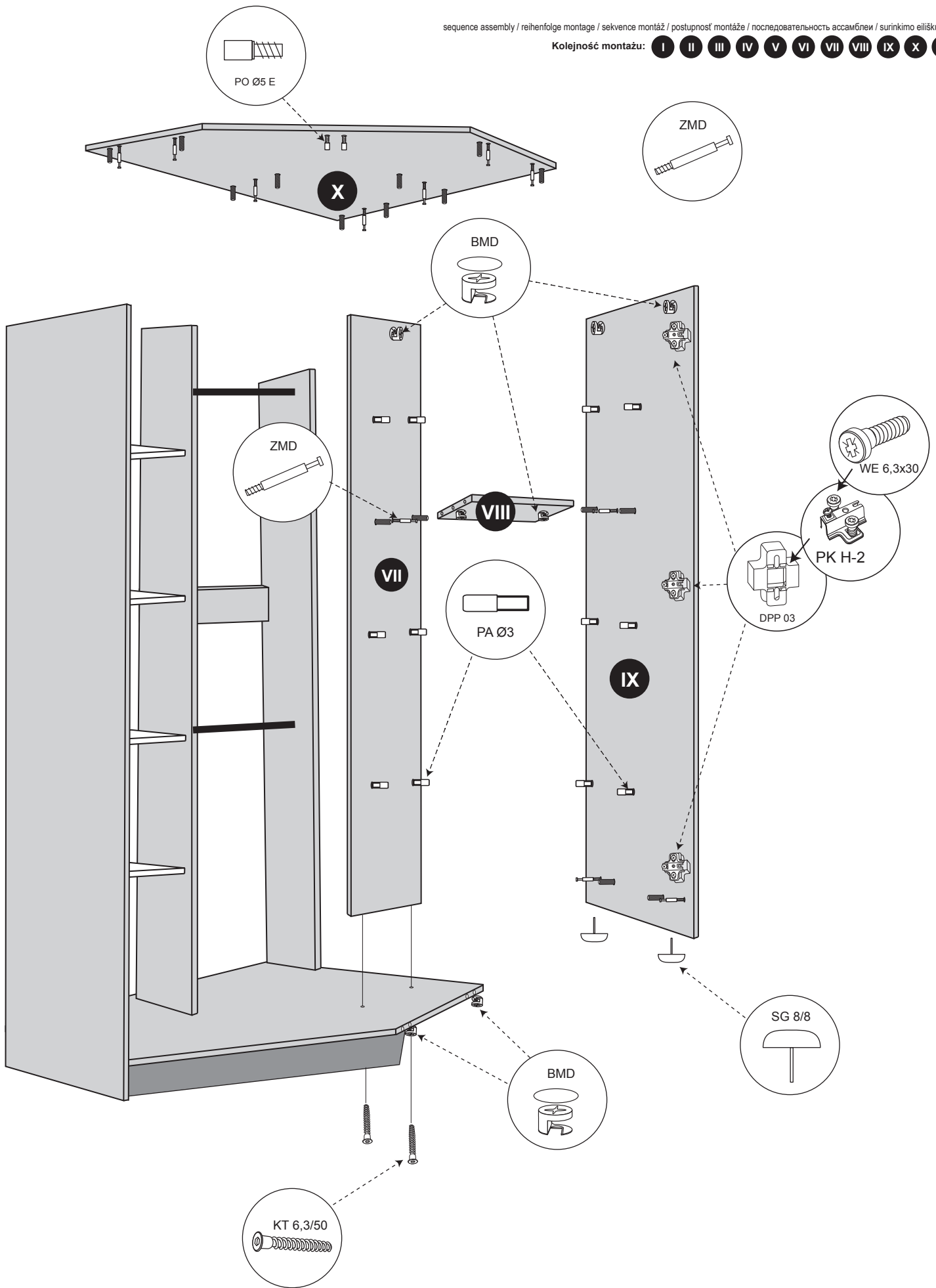

XI

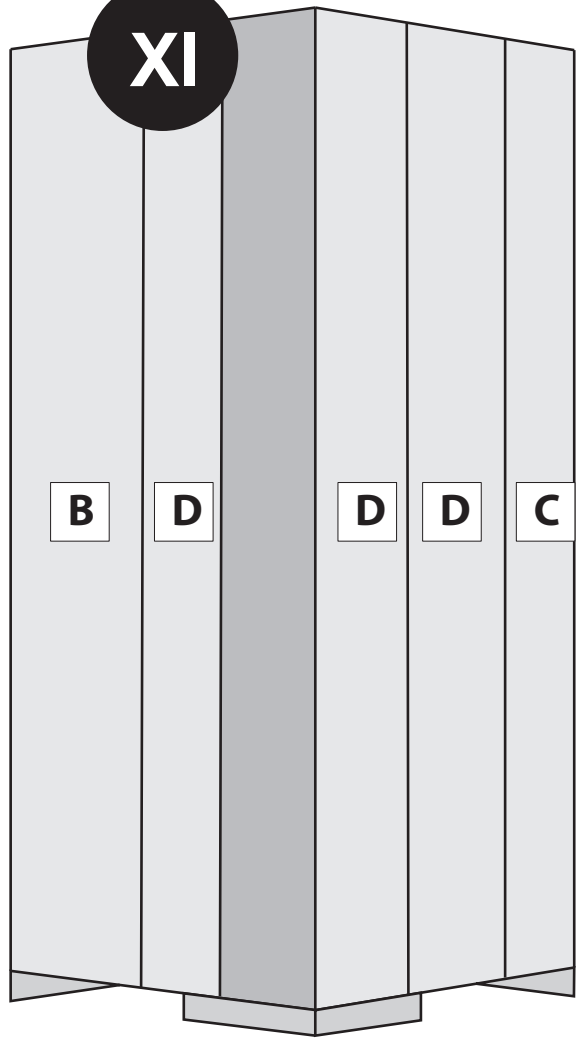

- B** 1908 x 337
- C** 1908 x 273
- D** 1908 x 307

