



www.MLMEBLE.pl

GB assembly instructions / D montageanleitung / CZ montážní návod / SK montážny návod / RUS инструкции по монтажу / LT surinkimo instrukcija





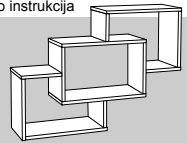

INSTRUKCJA MONTAŻU

PORTO 12
↑64 →80 ↗23

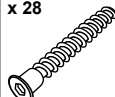

akcesoria / accessories / zubehör / příslušenství / prislušenstvo / аксессуары / furnitūra :

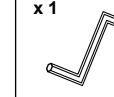
x 28  KT 6,3/50	x 28  ZAK	x 8  WT 3x30	x 4  ZAM 13x60	x 1  kluczyk / key / schlüssel / klíč / kľúč / ключ / raktas
--	--	---	---	---

do montażu potrzebne są:
are needed for assembly:
sind erforderlich für die montage:
jsou potřebné pro montáž:
sú potrebné pre montáž:
которые необходимы для сборки:
Surinkimui reikės

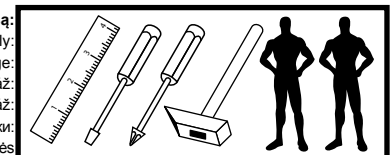

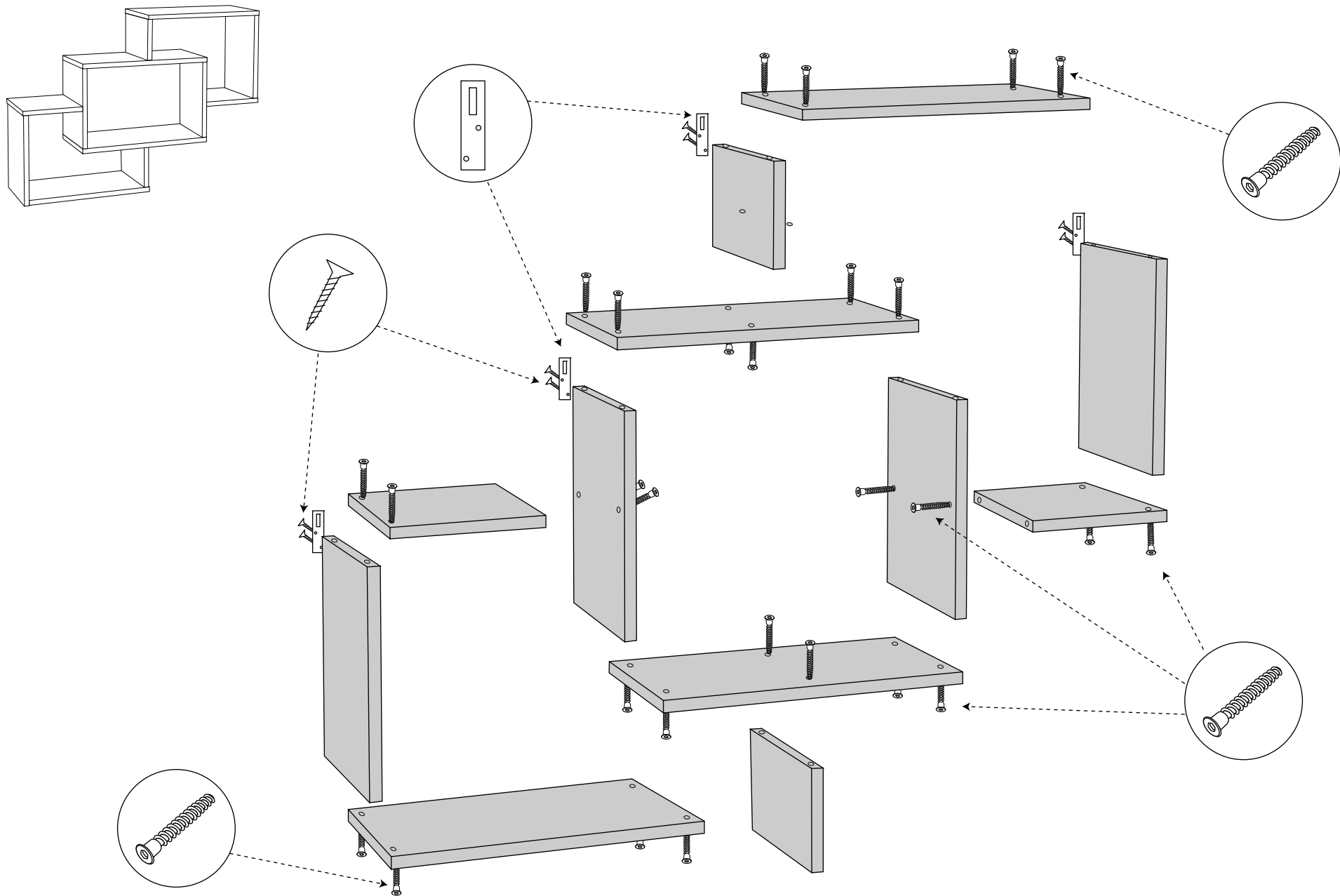

!
UWAGA! - w pierwszej kolejności wbijamy akcesoria „KK” i „MD” w blaty oraz boki.
WARNING! - The first accessory sticks "KK" and "MD" in the tops and sides.
WARNING! - Die erste Accessoire-Sticks "KK" und "MD" in den Spitzen und an den Seiten.
POZOR! - První příslušenství holí "KK" a "MD" v korunách a boky.
POZOR! - Prvé príslušenstvo palíc "KK" a "MD" v korunách a boky.
ВНИМАНИЕ! - Первый аксессуаров палочки "KK" и "MD" по вершинам и по бокам.
DĚMESIO! - Pirmiausiai furnitūrą KK ir MD įkalame į stalviršį ir šonus.