

JORMA

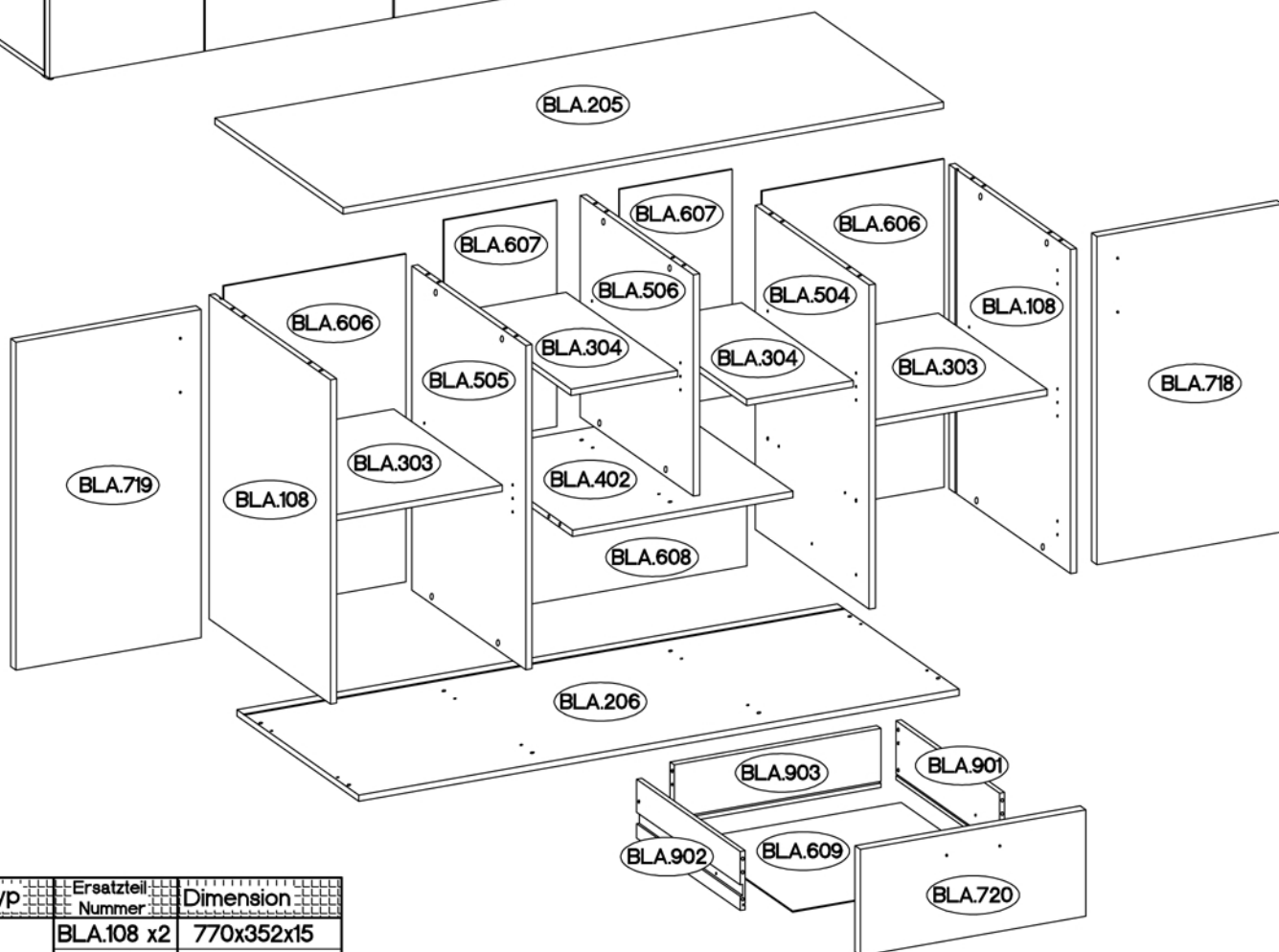

Coli	Typ	Ersatzteil Nummer	Dimension
1/2	872	BLA.108 x2	770x352x15
		BLA.205	1447x372x15
		BLA.206	1447x353x15
		BLA.303 x2	426x315x15
		BLA.304 x2	257x323x15
		BLA.504	770x330x15
		BLA.505	770x330x15

Coli	Typ	Ersatzteil Nummer	Dimension
2/2	872	BLA.402	531x329x15
		BLA.506	526x328x15
		BLA.606 x2	779x439x2,5
		BLA.607 x2	537x272x2,5
		BLA.608	240x544x2,5
		BLA.609	296x508x2,5
		BLA.718	779x446x15
		BLA.719	779x446x15
		BLA.720	543x253x15

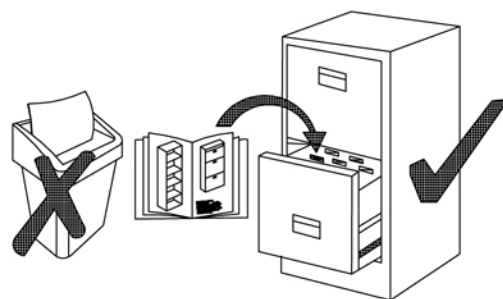
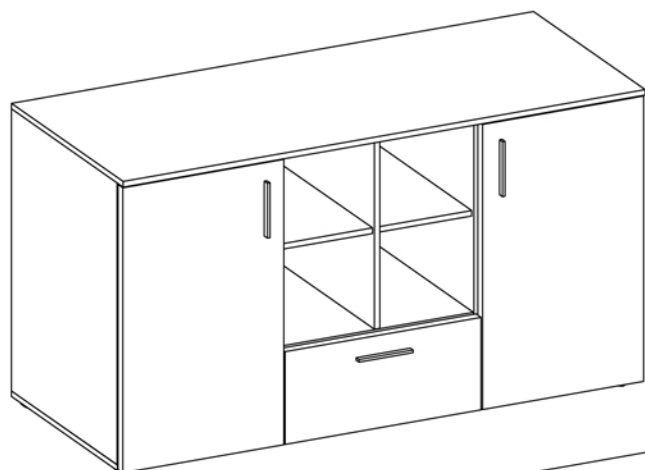
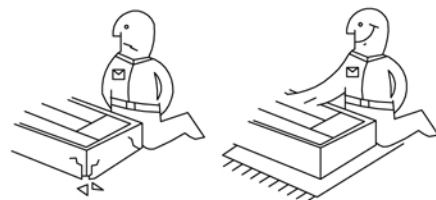
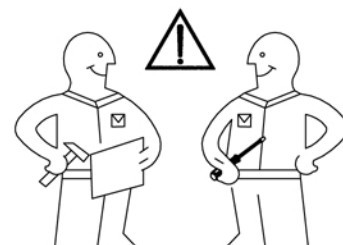

JORMA

Typ 872

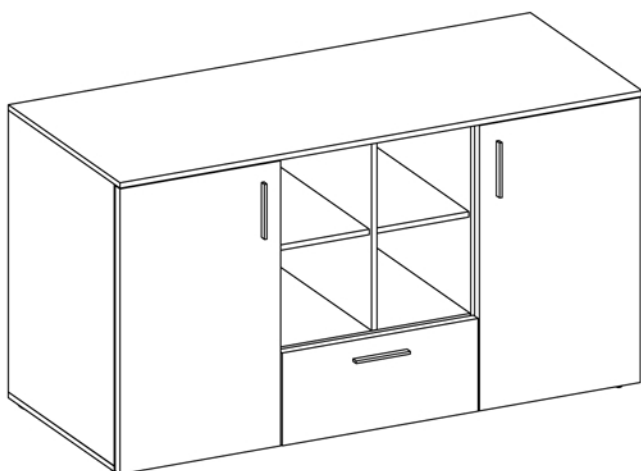

BLA.205 = max. 10kg

BLA.303
BLA.304 = max. 5kg

BLA.402

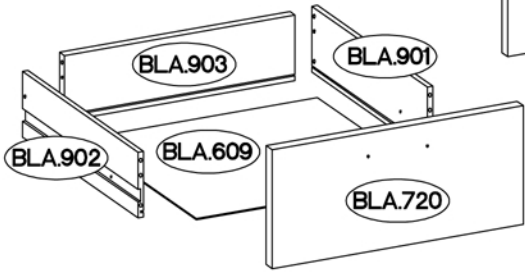







†4.0x25mm
 P14
6

†10x50mm
 O7
2
 L9
2

6	1	2	2	4	1	4	4	10
†15/12mm 	†8x30mm 	L=20mm 		L=128mm 	†4.0x27mm 			†3.0x20mm
24	34	24	20	3	6	16	20	20

5B:

+4.0x25mm  P14 6	 F10 6	+15/12mm  C 24	+8x30mm  A 24	L=20mm  D2 24	+6,3x13mm  M2 4	27/246mm  I3 1
---	--	---	--	--	--	--

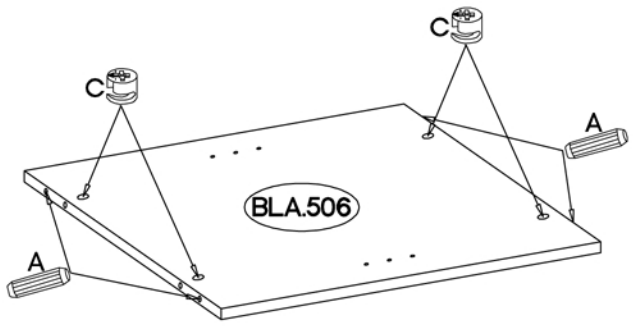
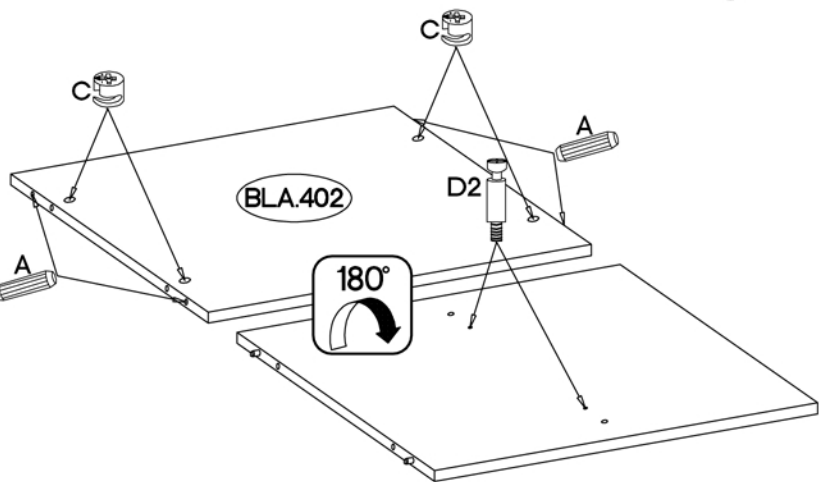
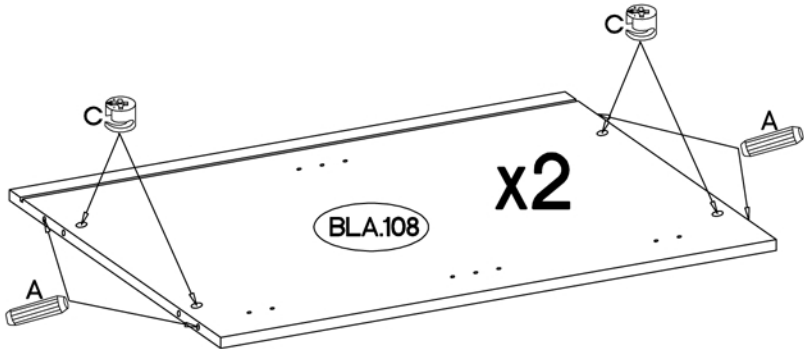
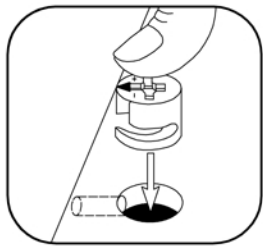
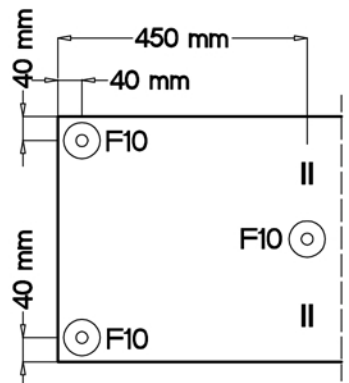
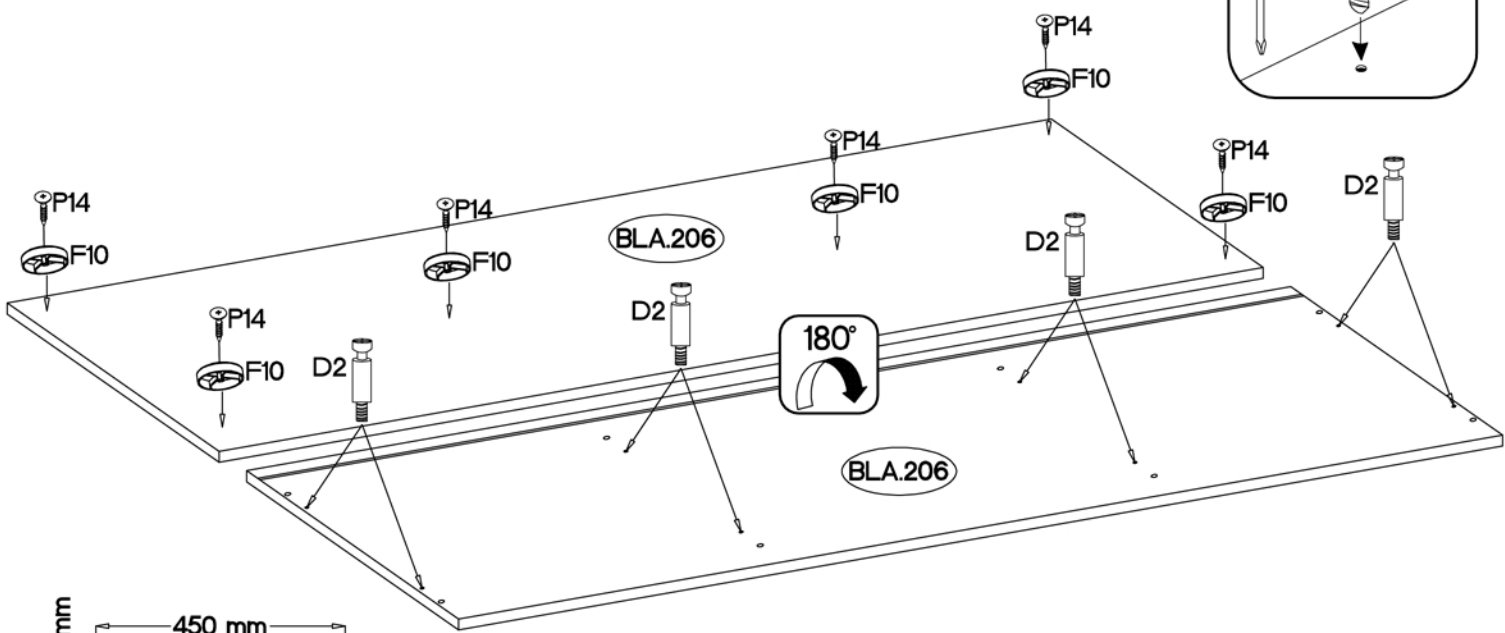
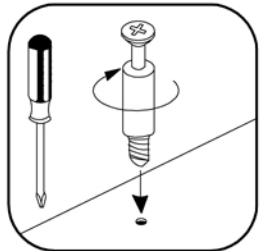
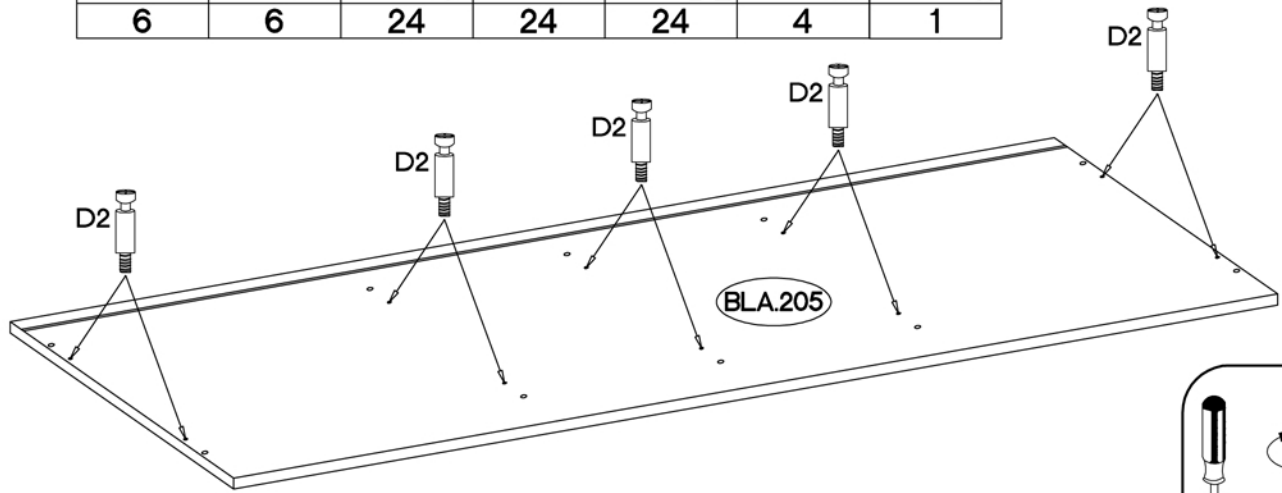

3

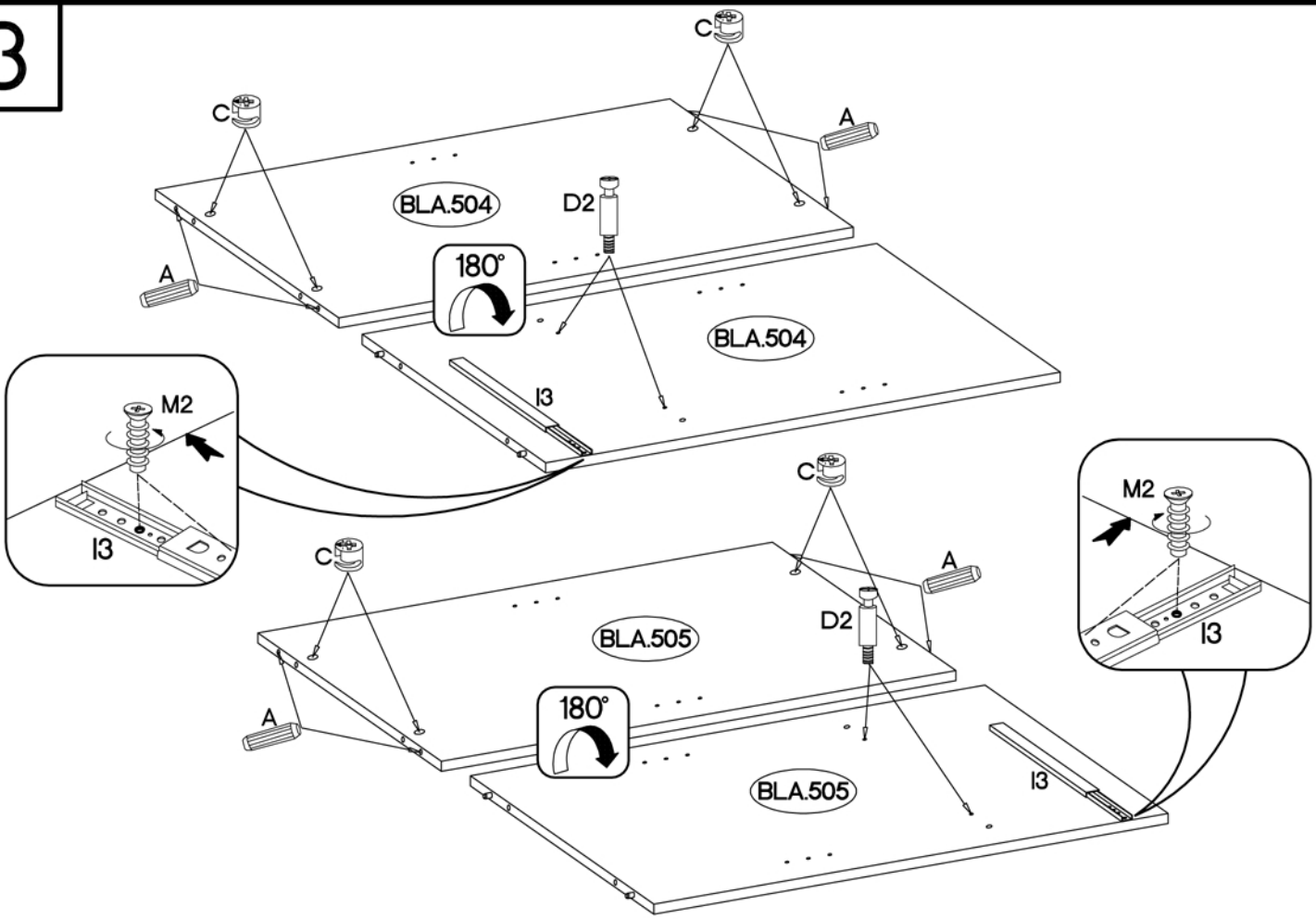

4

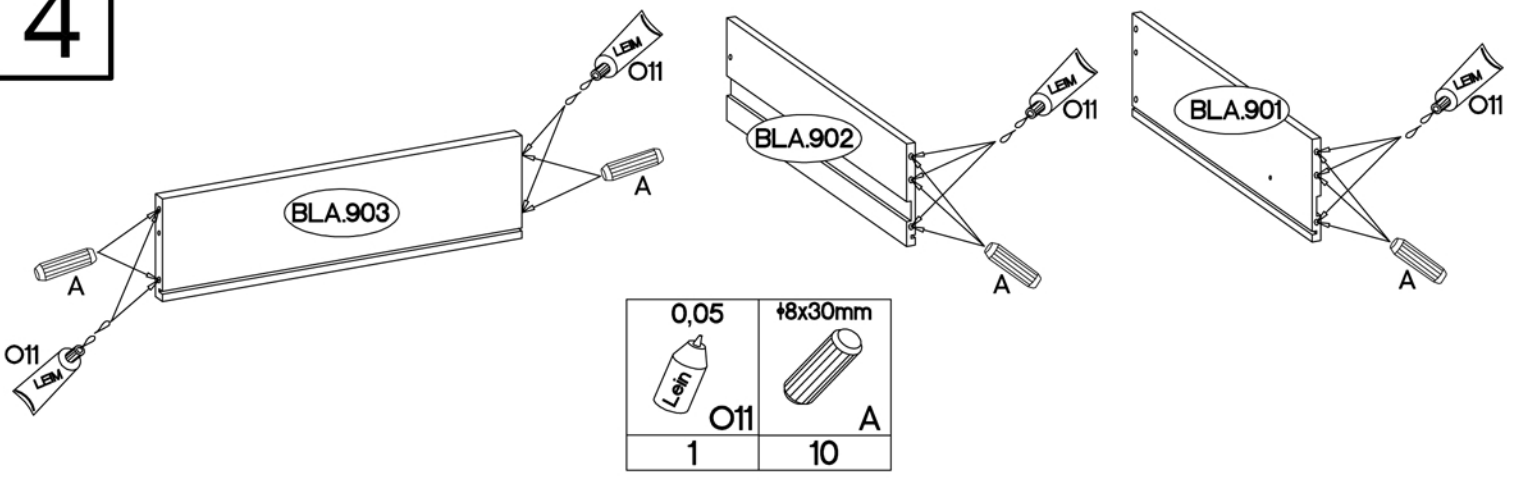

5

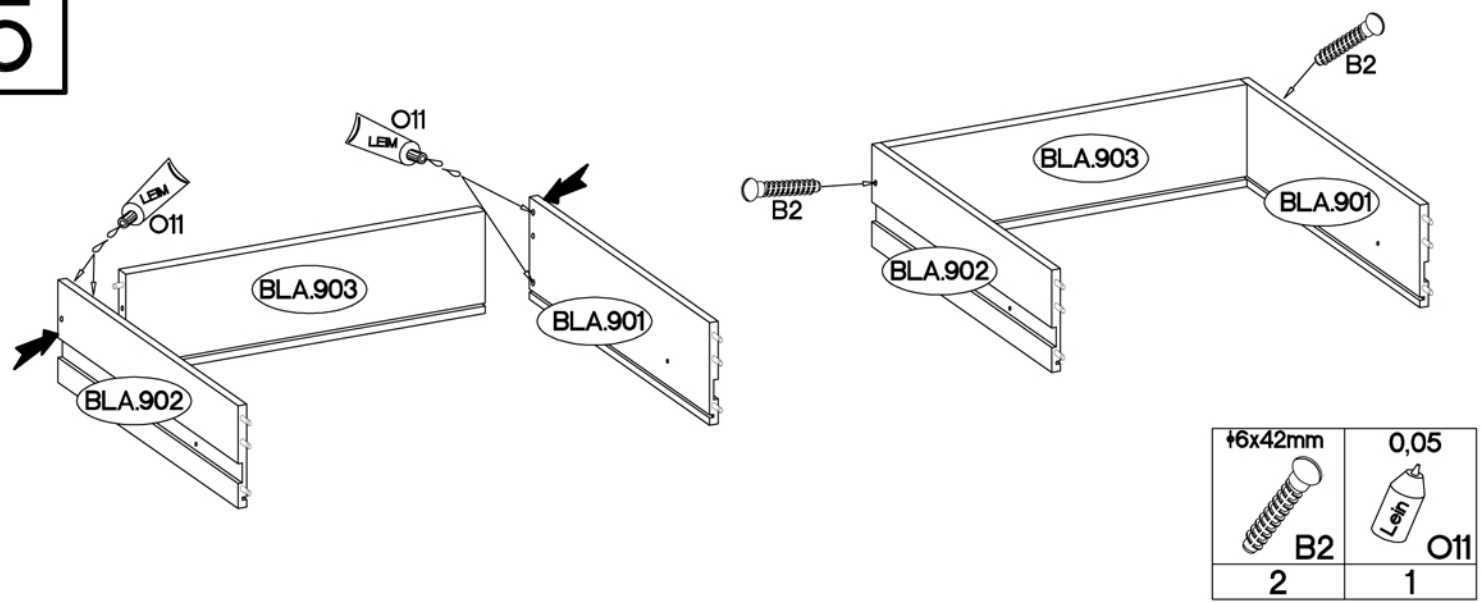

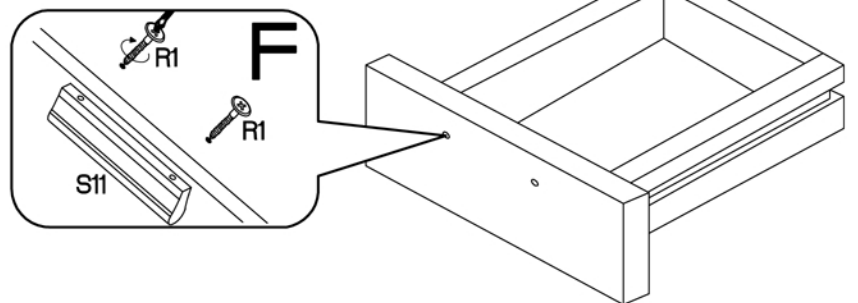
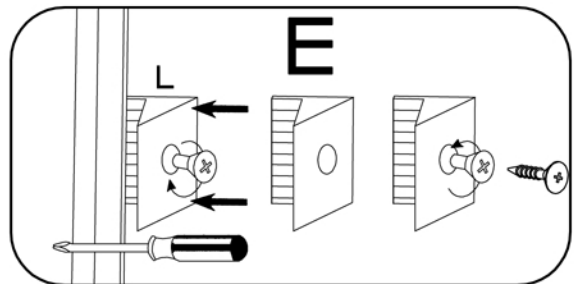
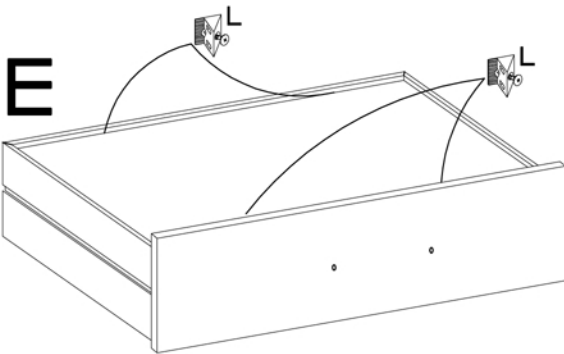
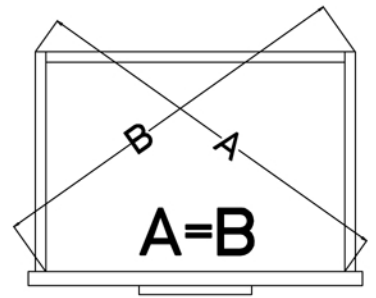
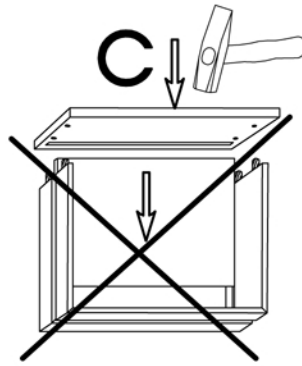
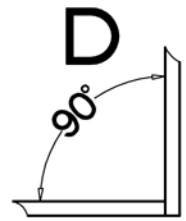
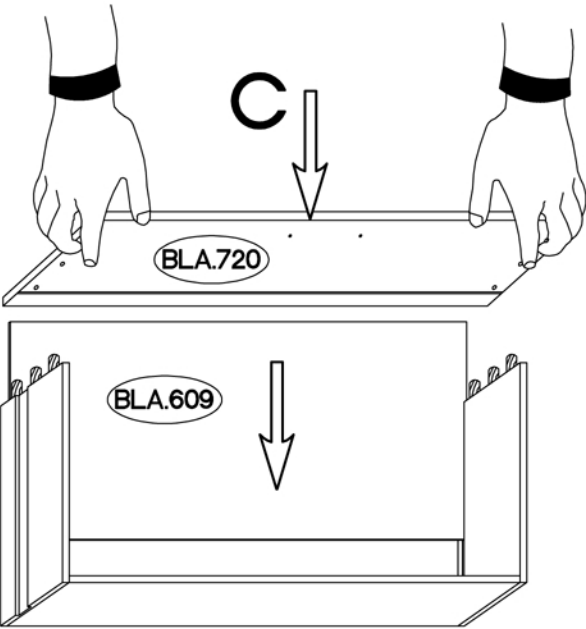
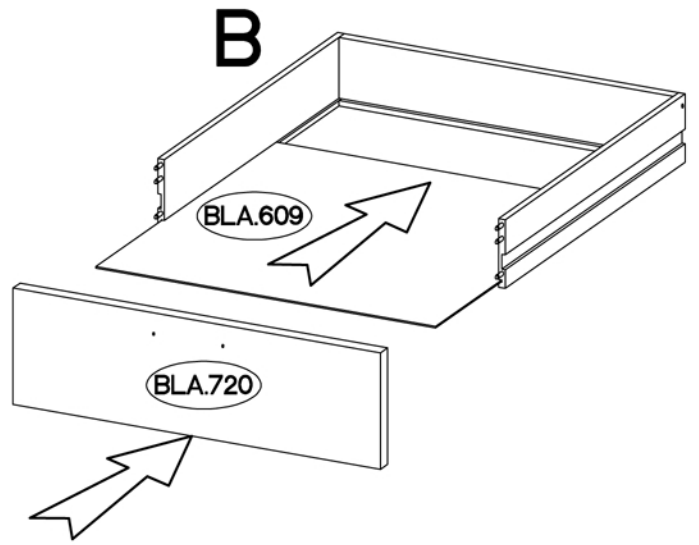
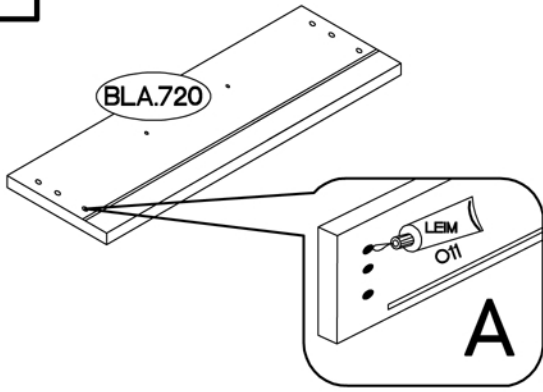

L=128mm	+4.0x27mm	0,05	
S11	R1	LEM 011	L
1	2	1	4

7

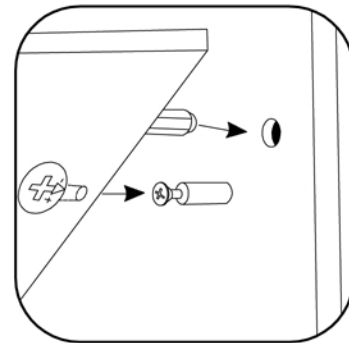
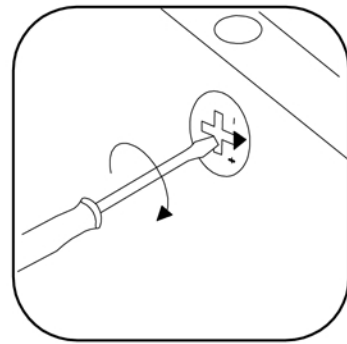
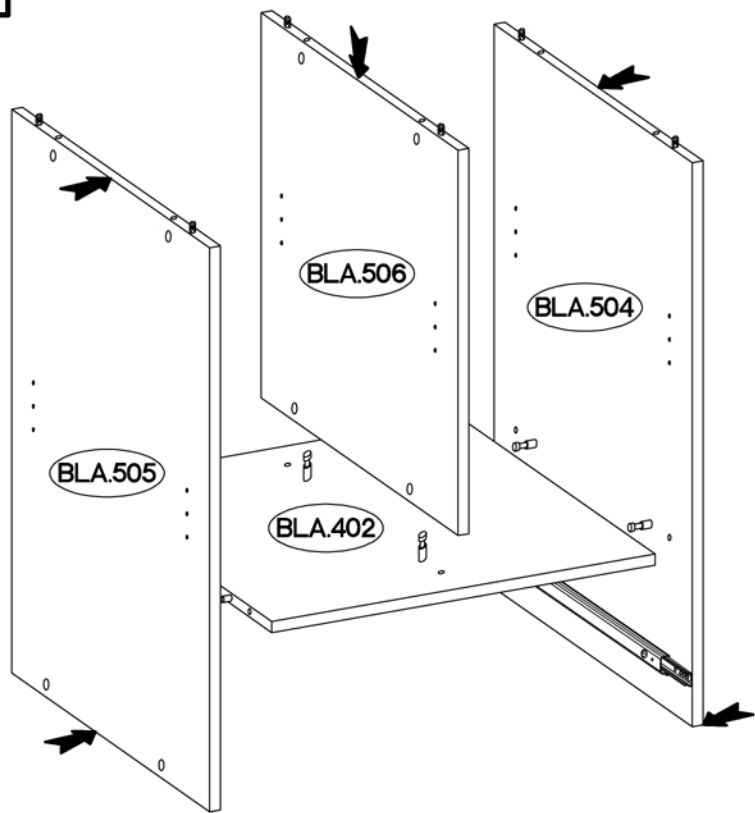

8

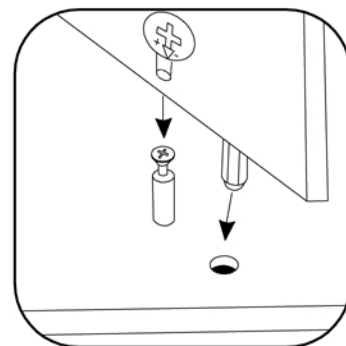
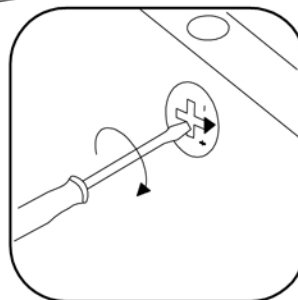
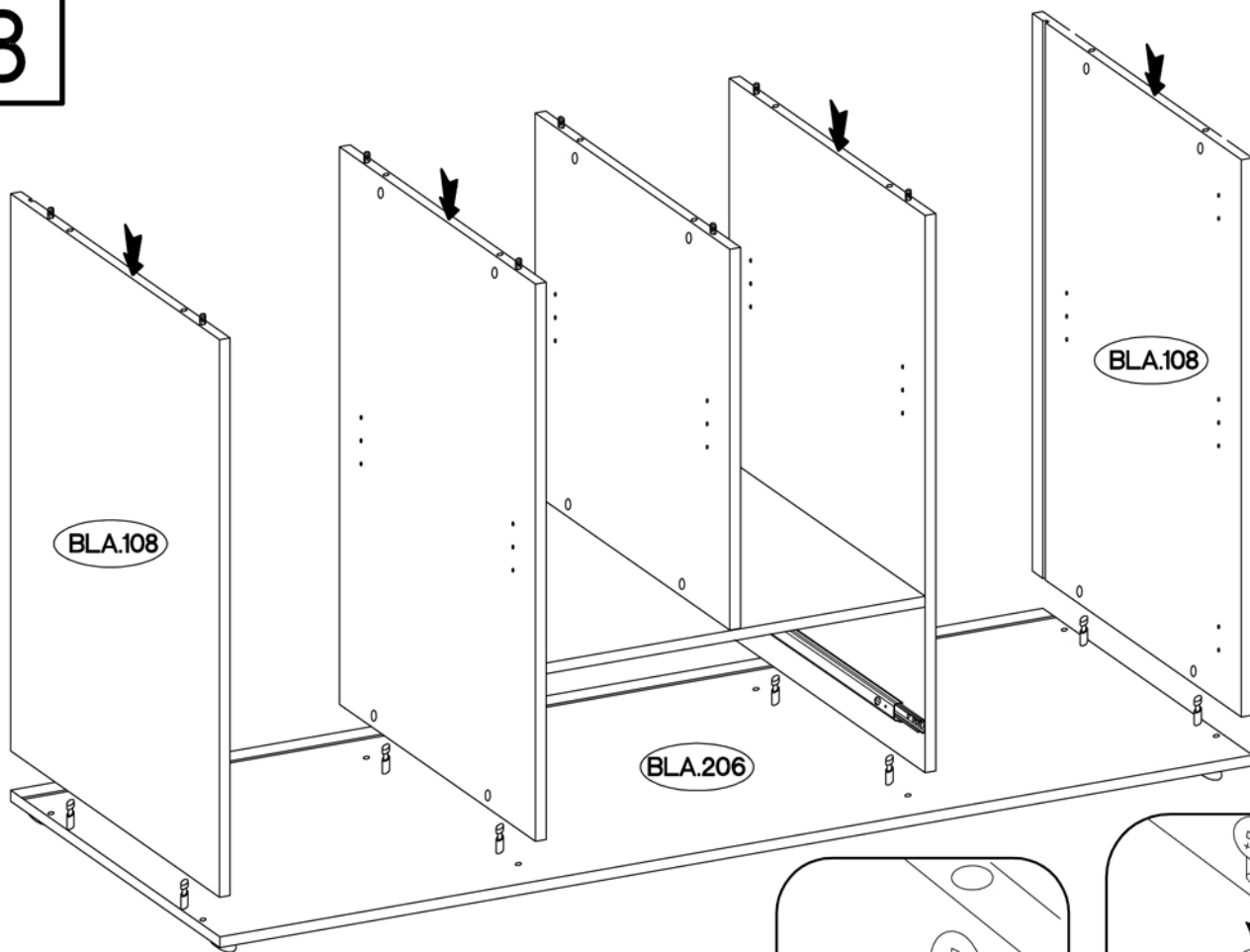

9

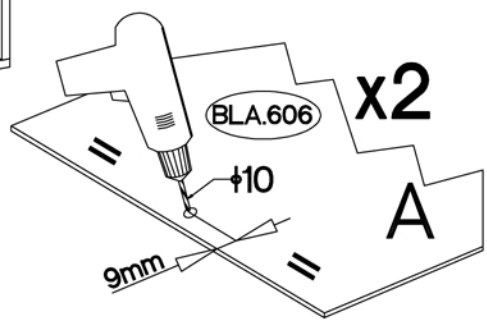
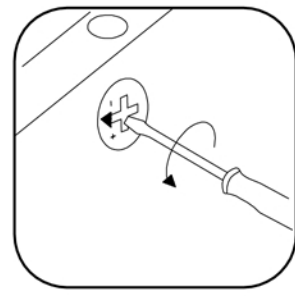
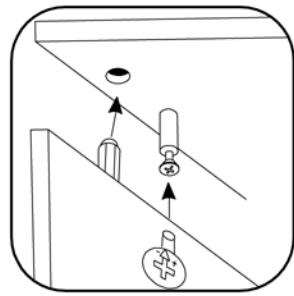
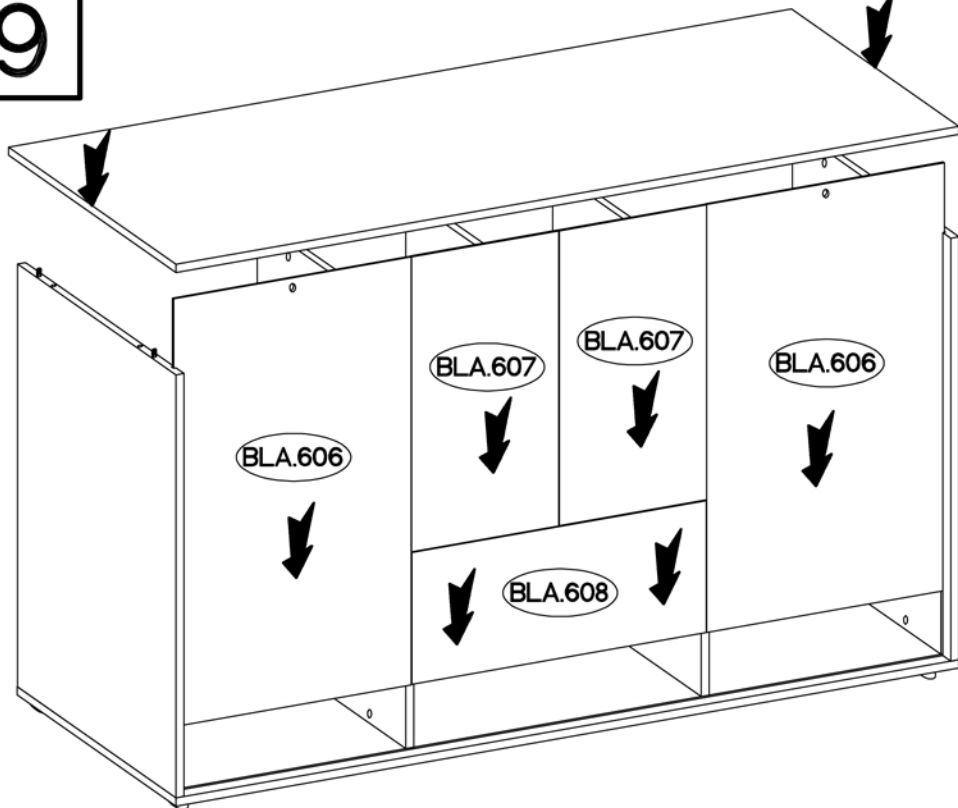

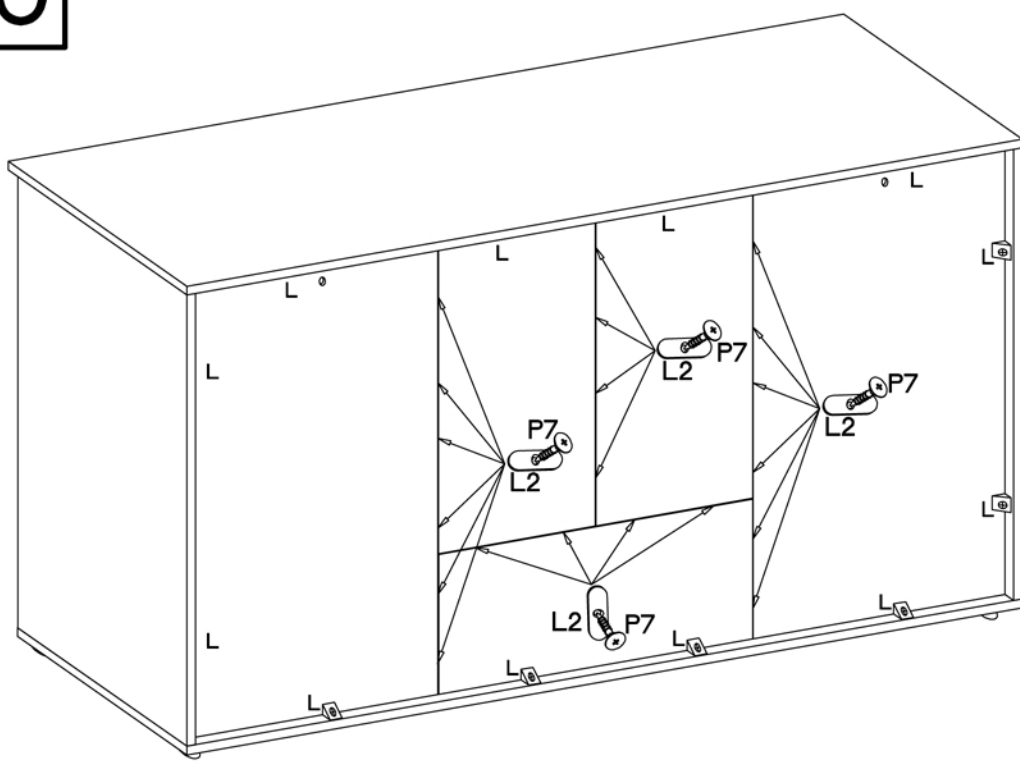

10

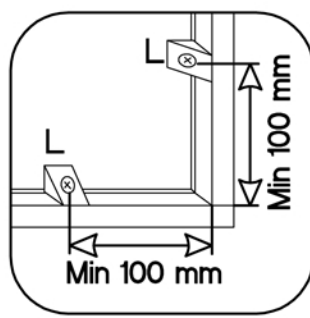
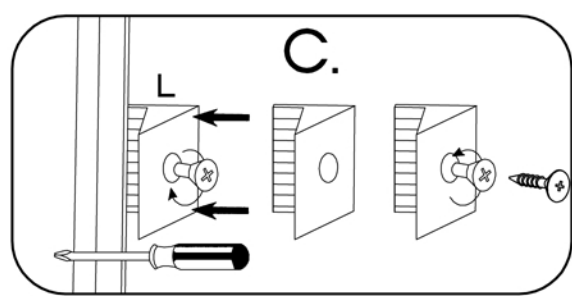
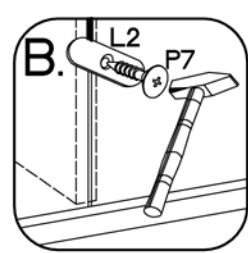
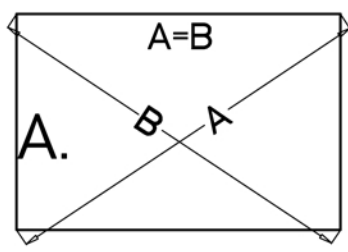

L2	L	P7
20	12	20



$\pm 3.5 \times 13 \text{mm}$  P5 2	$\pm 10 \times 50 \text{mm}$  O7 2	 L9 2
--	---	---

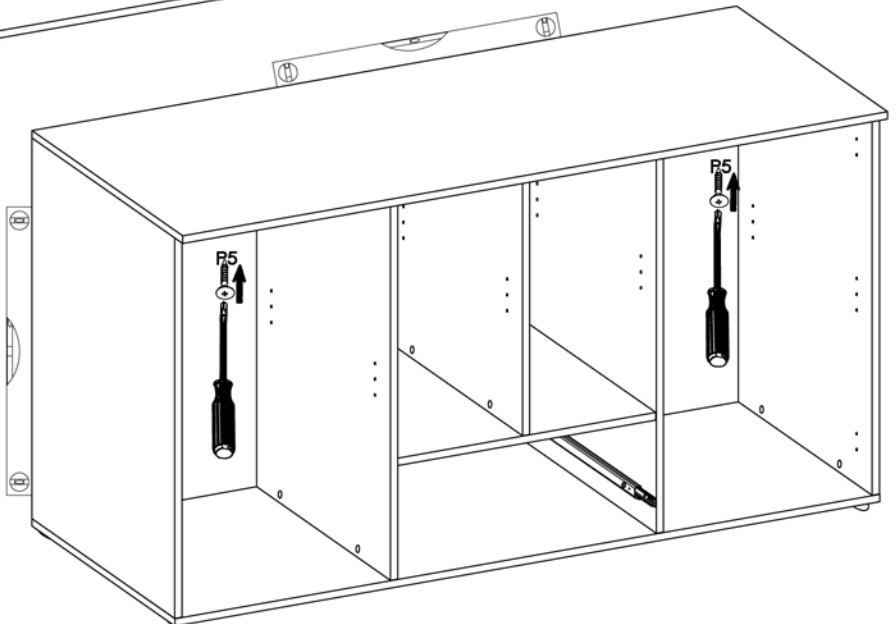
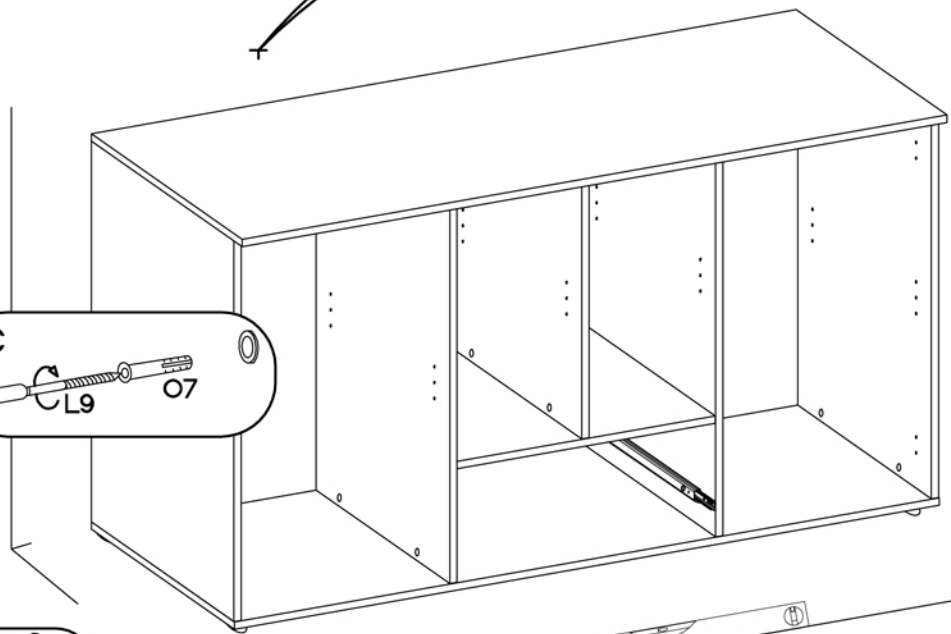
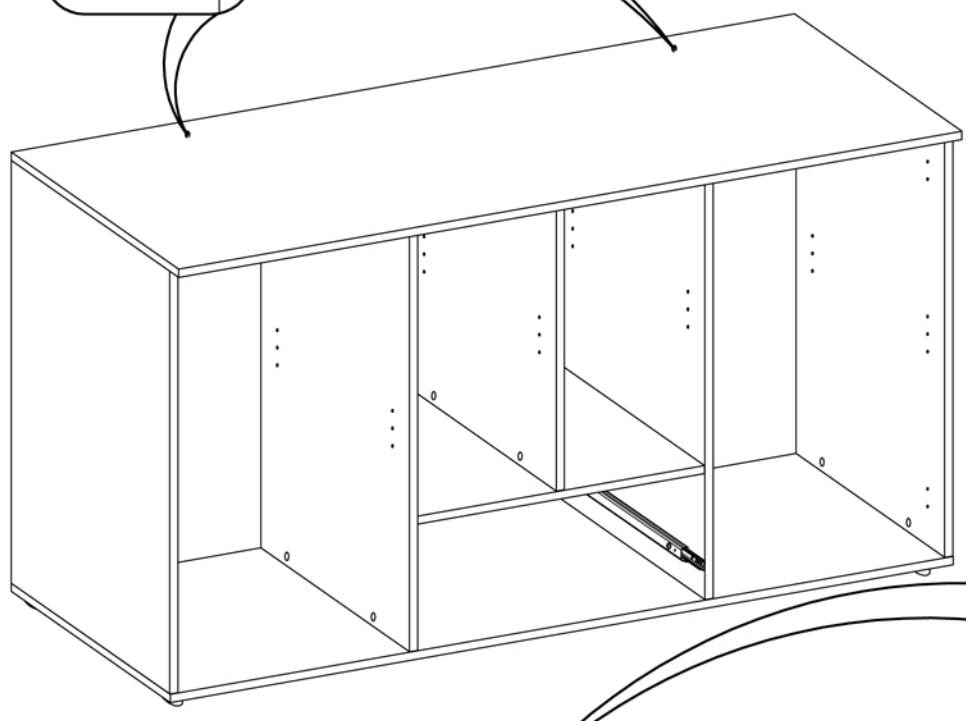
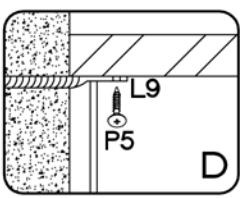
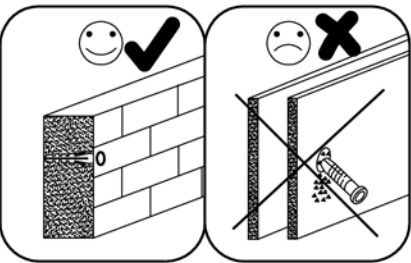
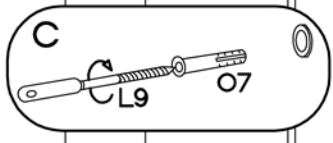
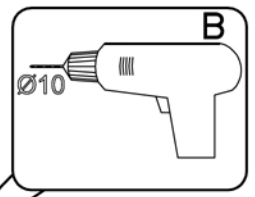
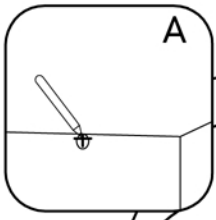

12

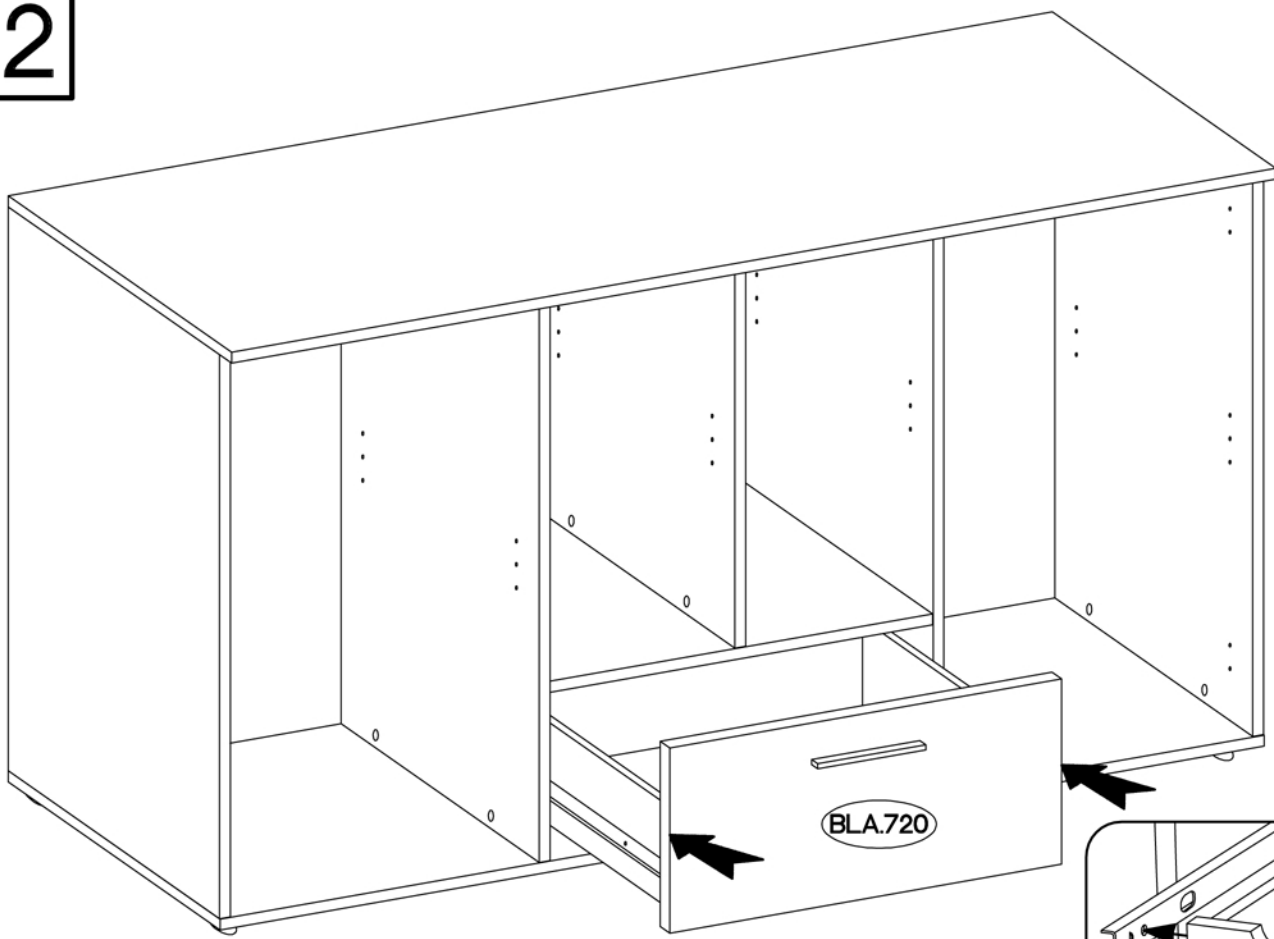

M4x9mm

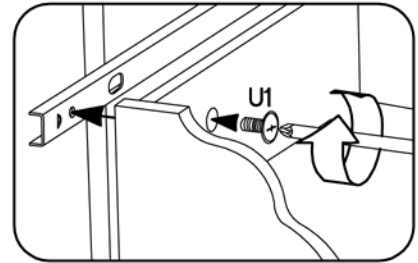
U1
2

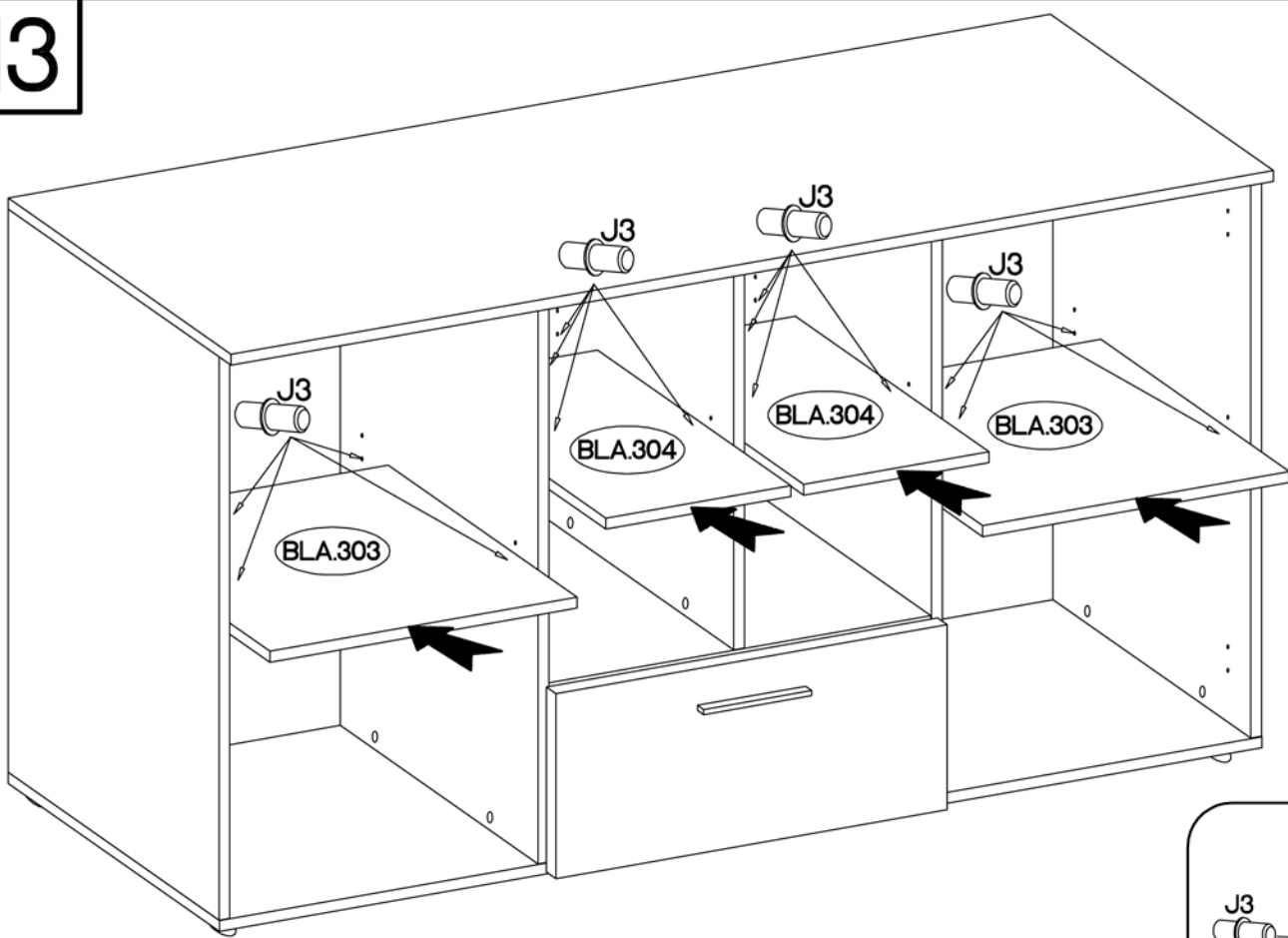

13



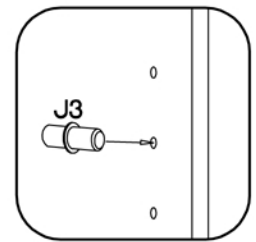

J3
16

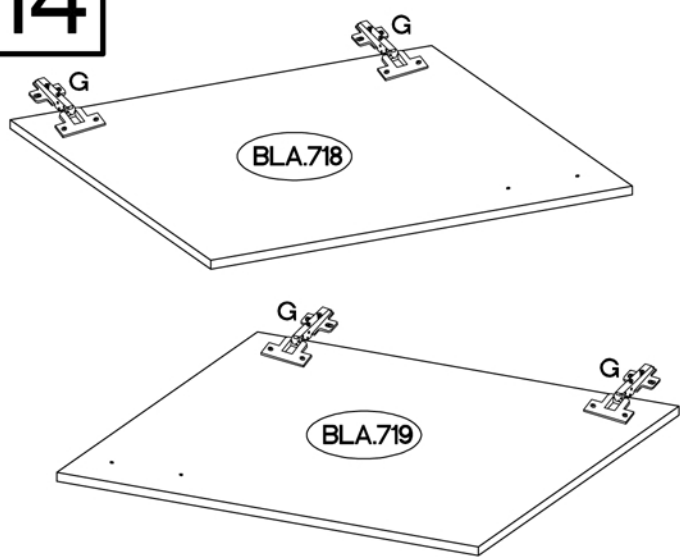

14

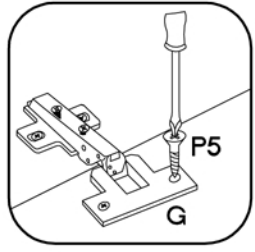
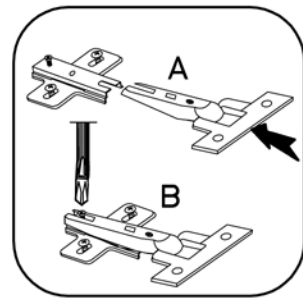

±35/0mm	H=0	±3.5x13mm
G	H	P5
4	4	8



15

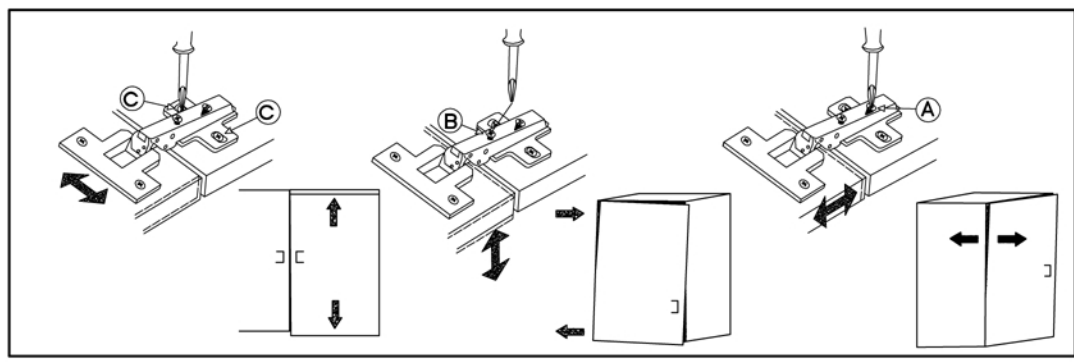
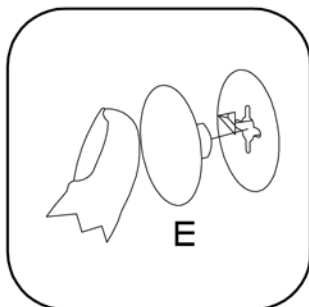
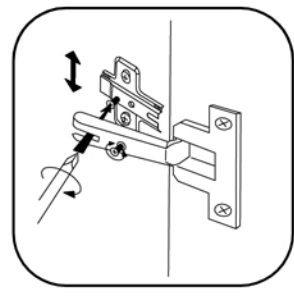
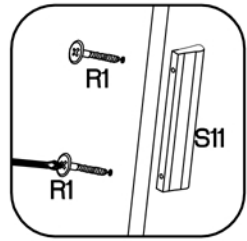
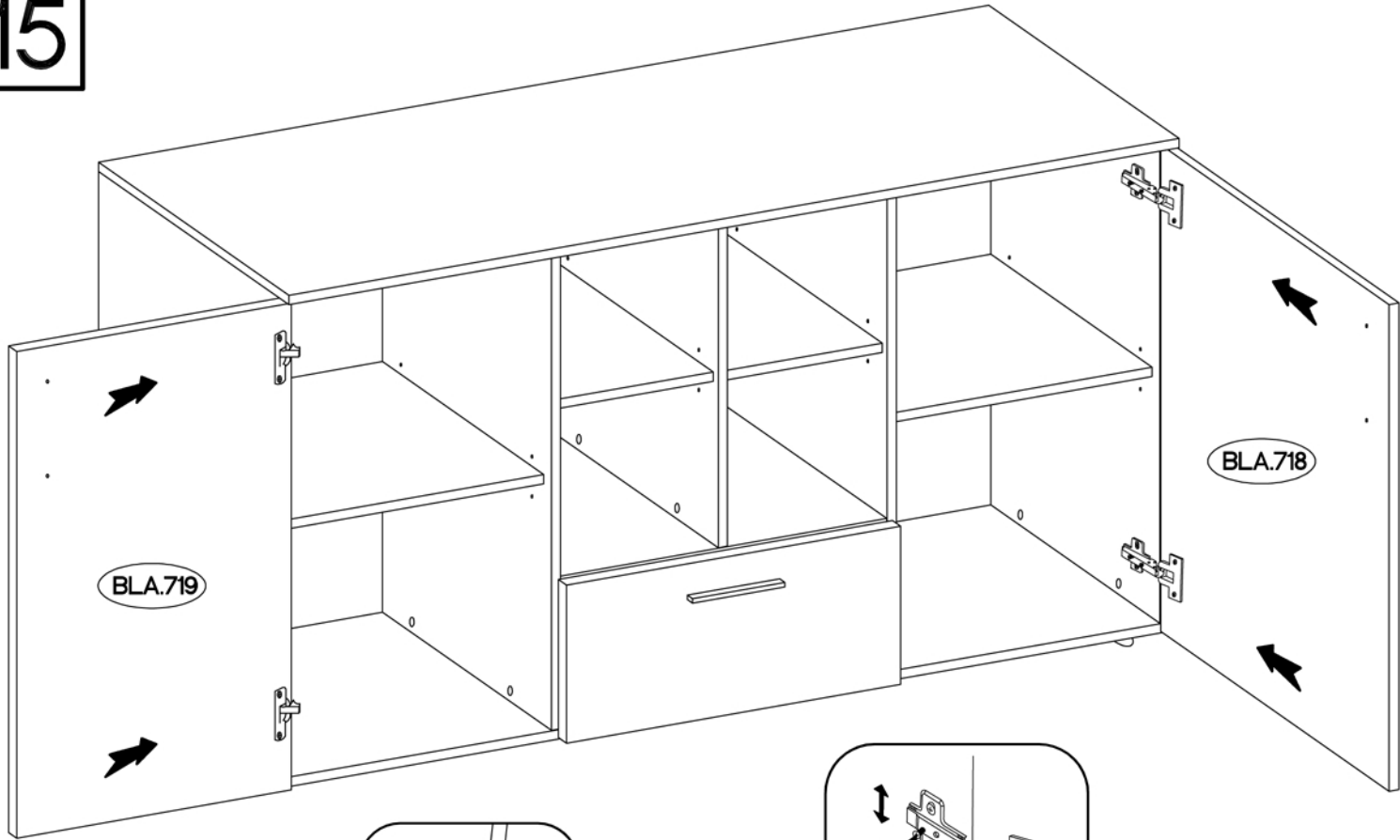

L=128mm	±4.0x27mm
E	S11
20	2
	R1
4	