















A	1x	1109x335
B	1x	1109x335
C	1x	1044x330
D	1x	1044x330
D1	1x	1044x311
G1	2x	1060x351
G2	1x	1060x384
I,J	2x	1038x339
H	2x	687x291
H1	2x	368x305

Z1	12x	
Z2	1x	
Z3	6x	
Z10	1x	
Z16	8x	
Z29	6x	
Z30	6x	
Z33	6x	
Z40	8x	
Z58	4x	
Z78	16x	
Z90	6x	
Z156	34x	
Z167	8x	
Z190	4x	

Z106	2x	
------	----	--

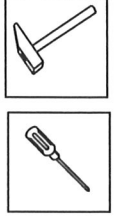
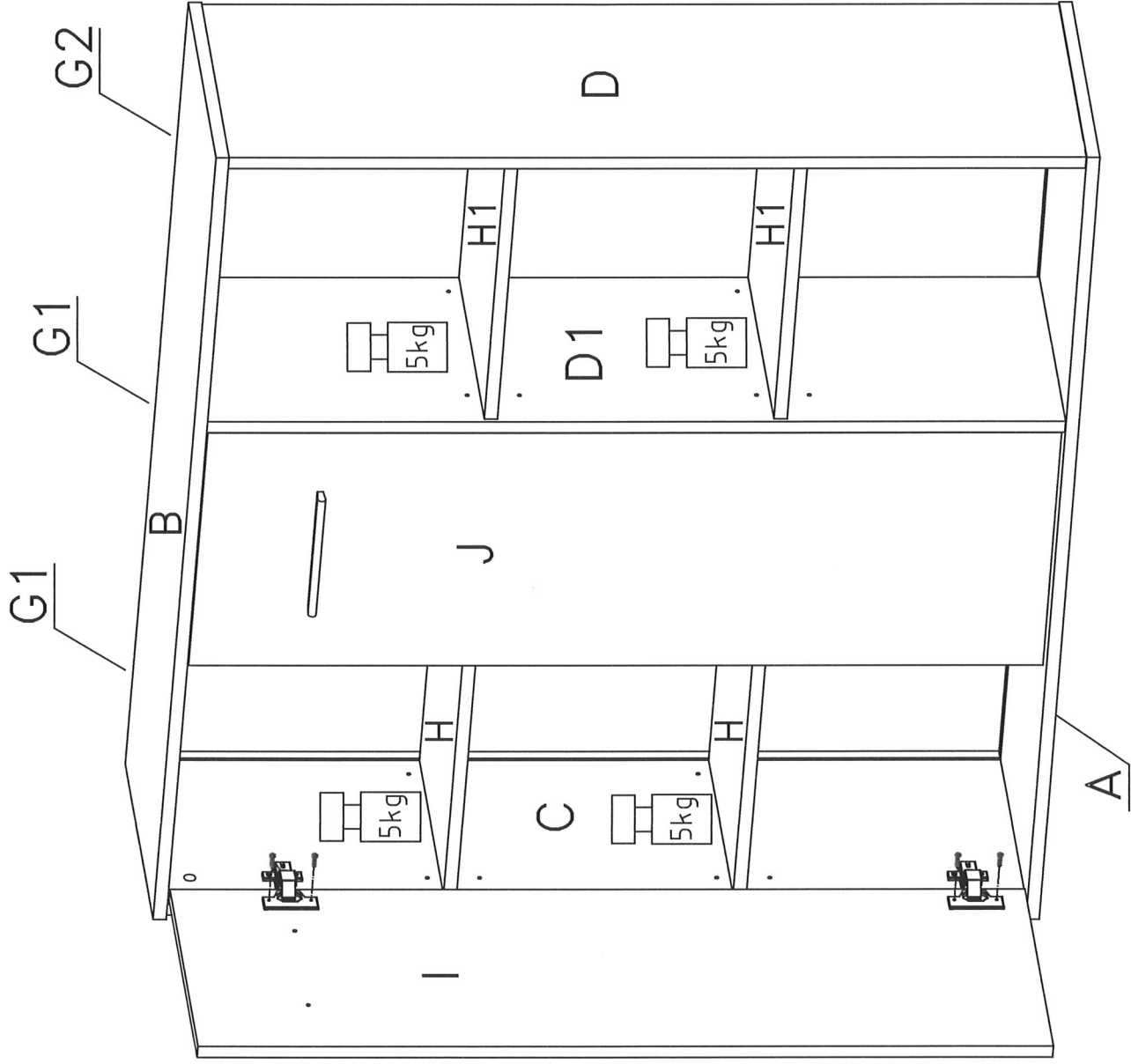

MA32

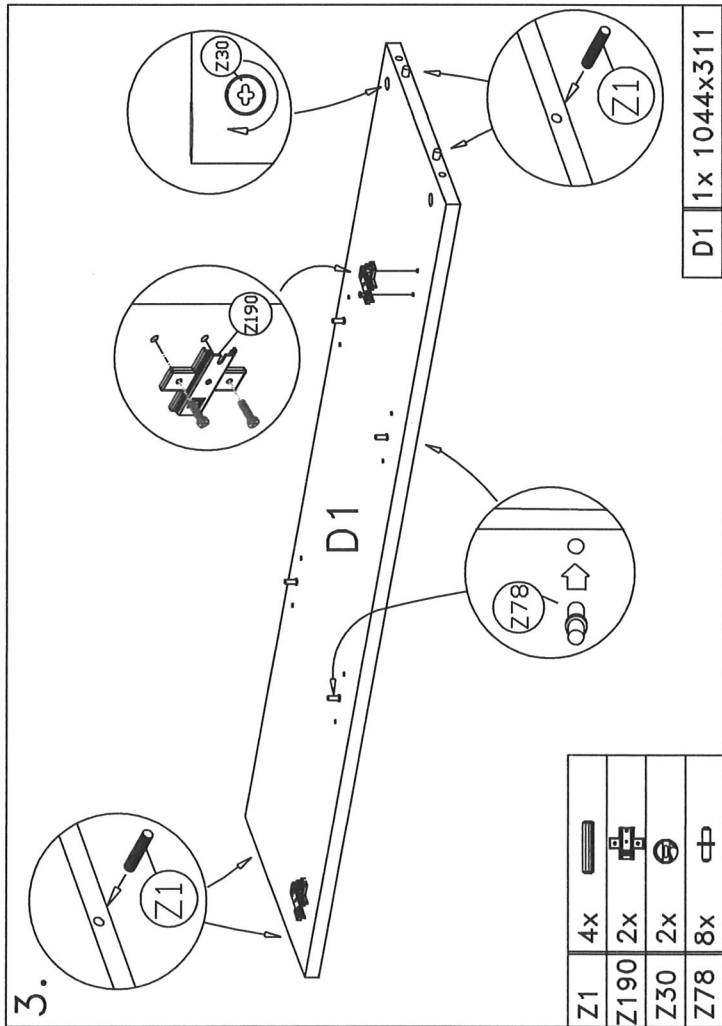
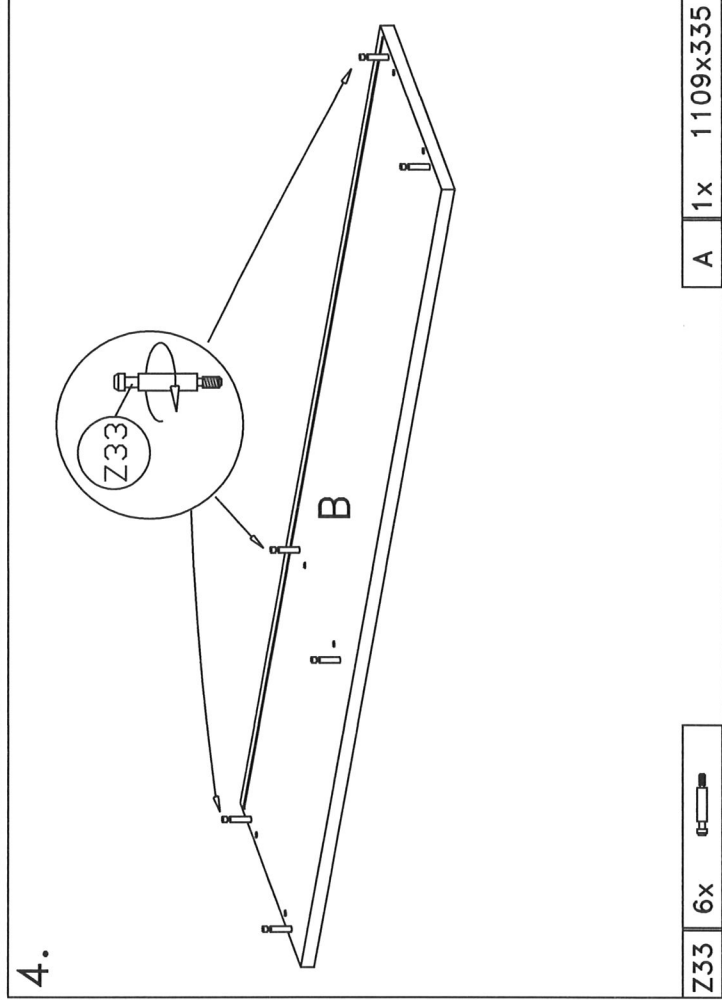
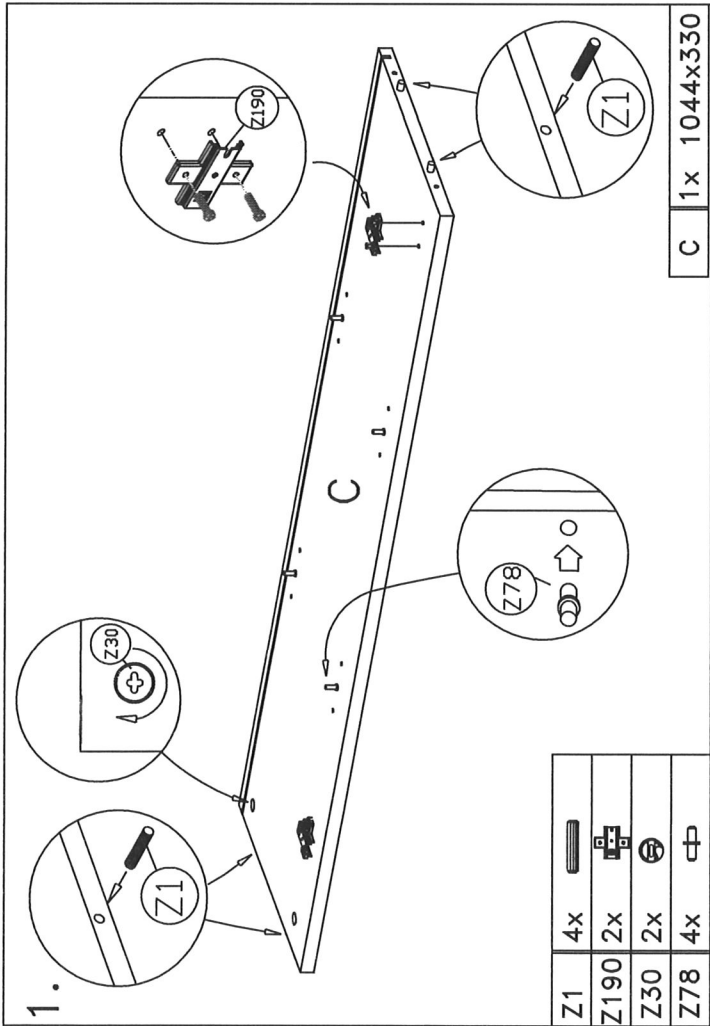
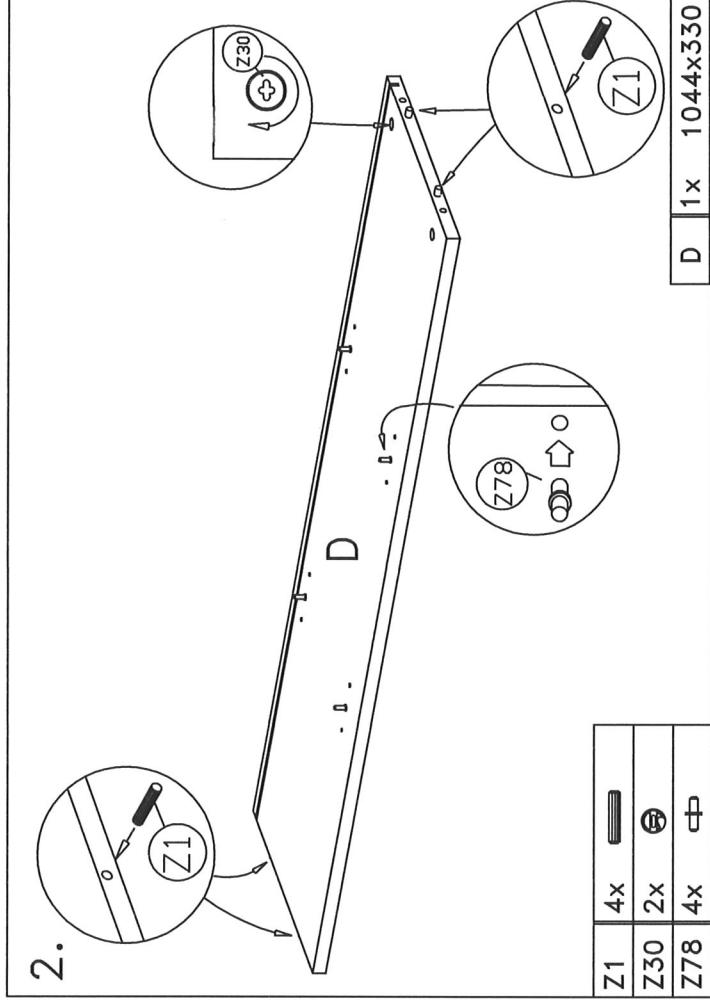

5.

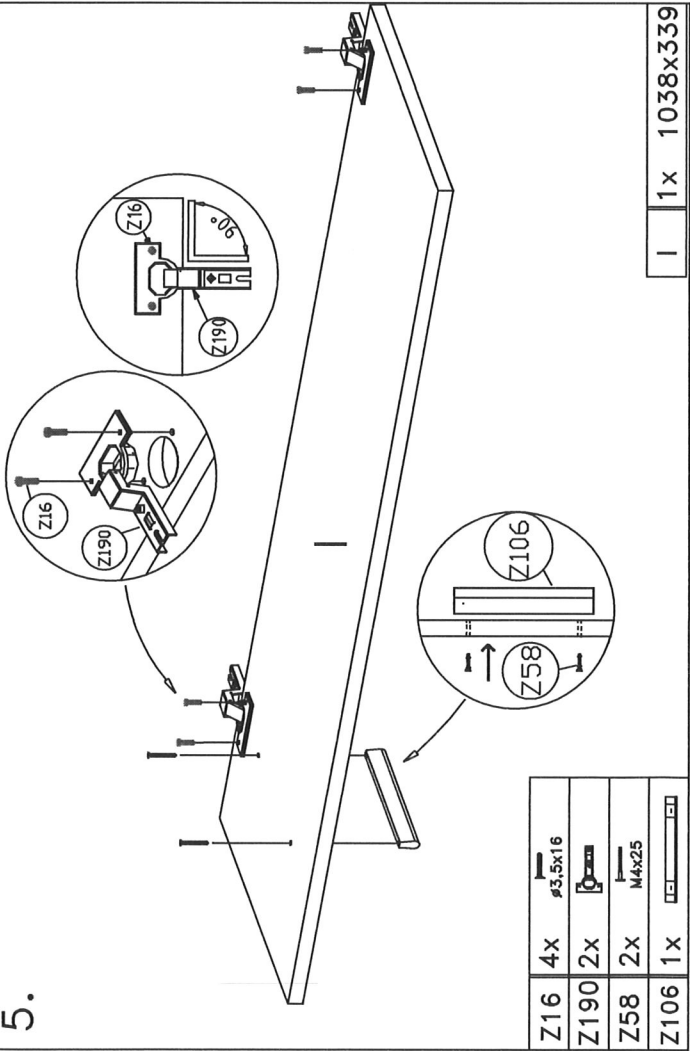

Z16	4x	$\phi 3.5 \times 16$
Z190	2x	
Z58	2x	M4x25
Z106	1x	

I 1x 1038x339

6.

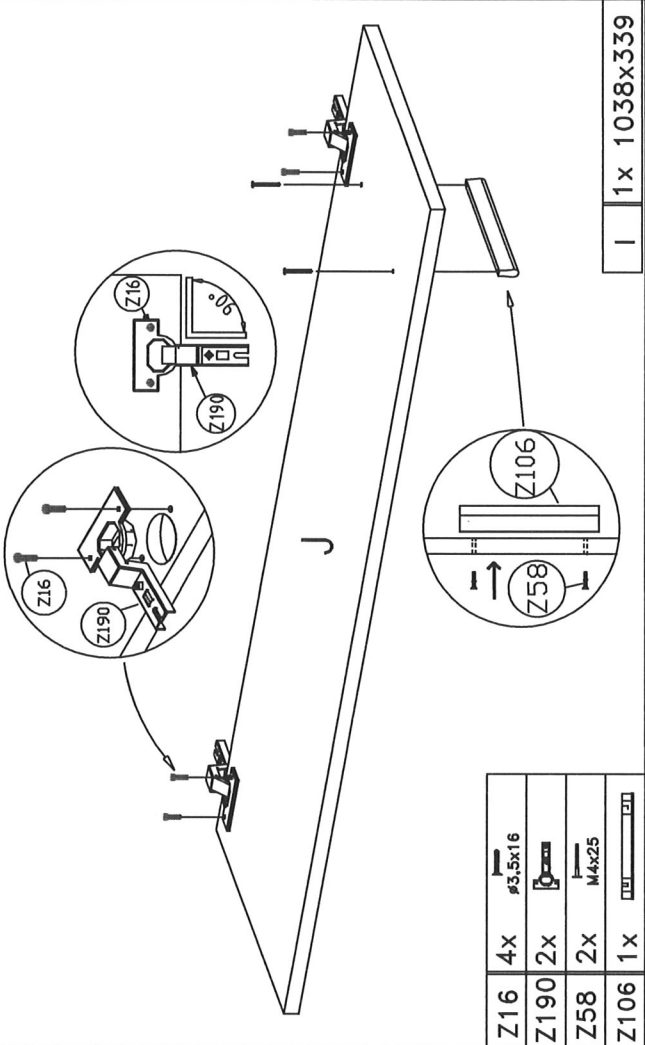

Z16	4x	$\phi 3.5 \times 16$
Z190	2x	
Z58	2x	M4x25
Z106	1x	

I 1x 1038x339

7.

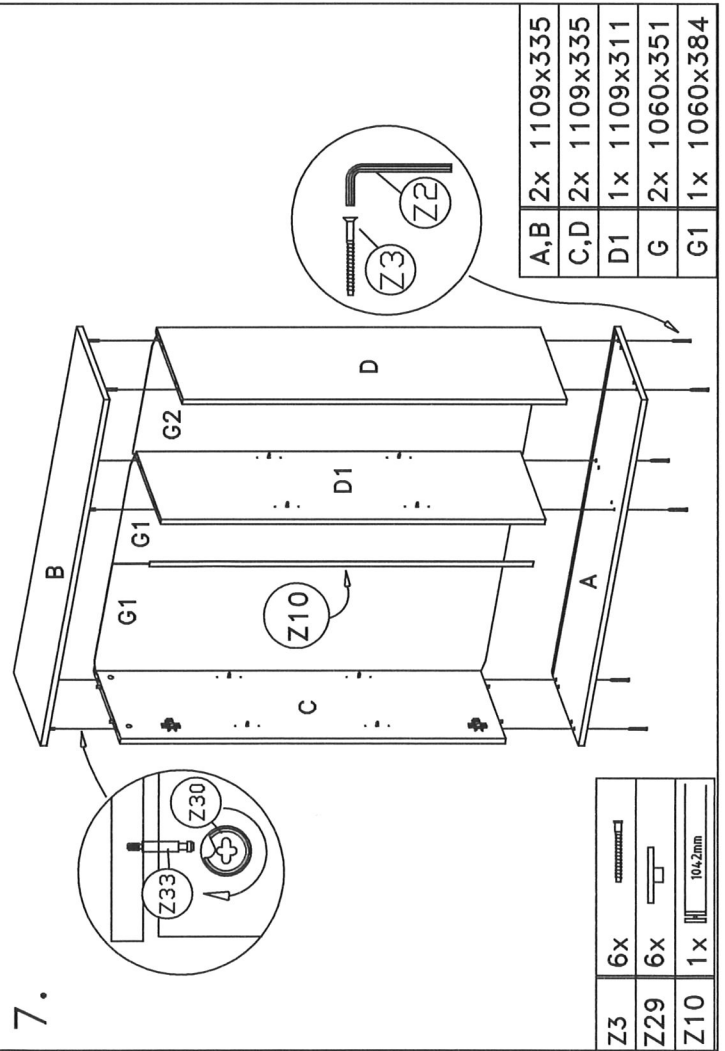

Z3	6x	
Z29	6x	
Z10	1x	104.2mm

A,B	2x	1109x335
C,D	2x	1109x335
D1	1x	1109x311
G	2x	1060x351
G1	1x	1060x384

8.

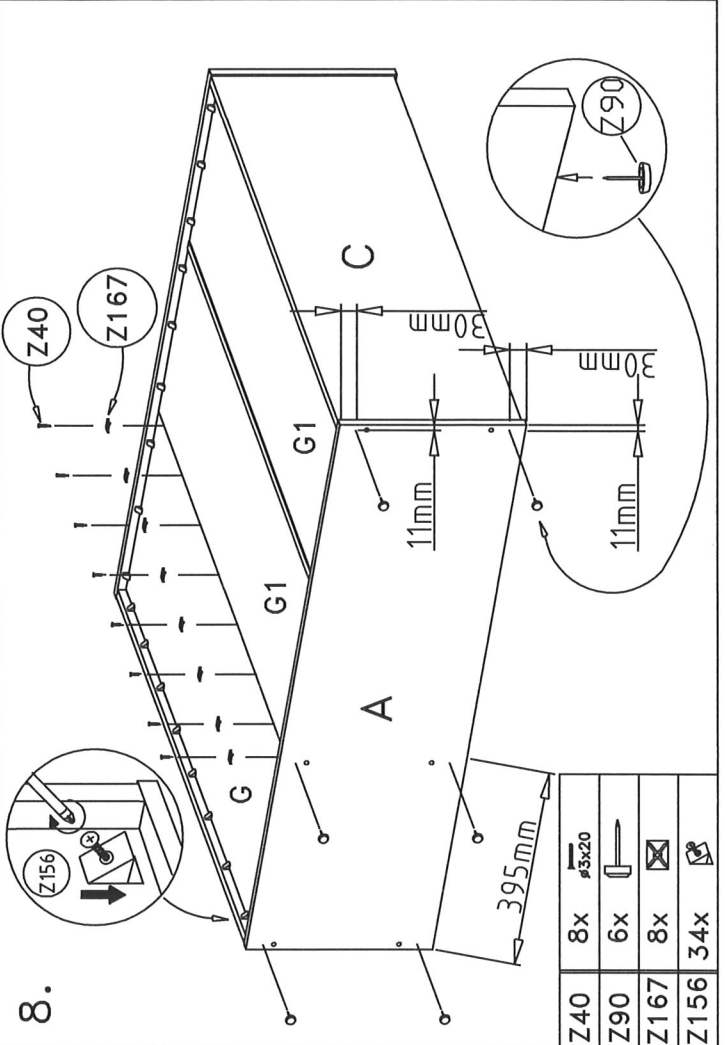

Z40	8x	$\phi 5 \times 20$
Z90	6x	
Z167	8x	
Z156	34x	

9.

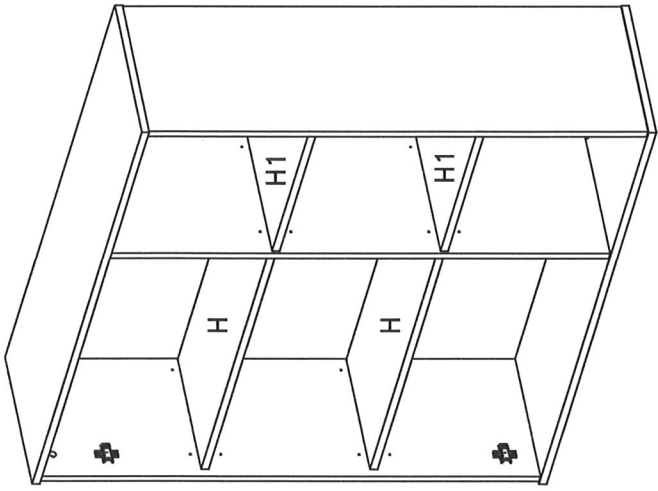

H	2x	687x291
H1	2x	368x305

10.

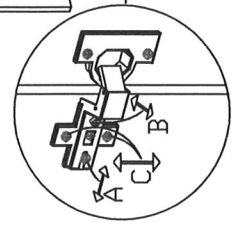
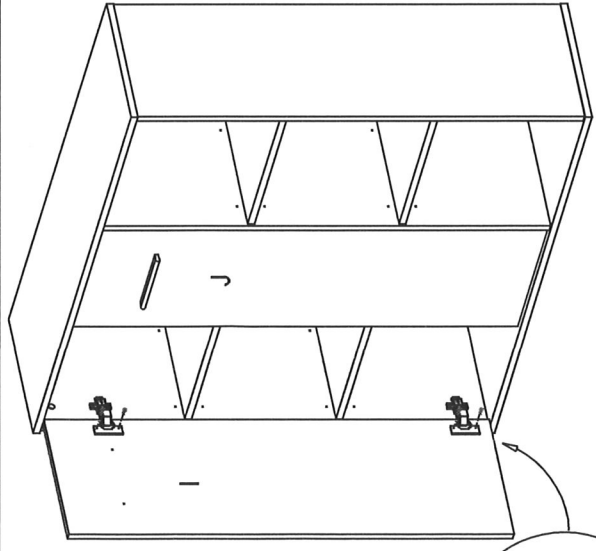

I	1x	1038x339
J	1x	1038x339