

Montážny návod

Upozornenie !







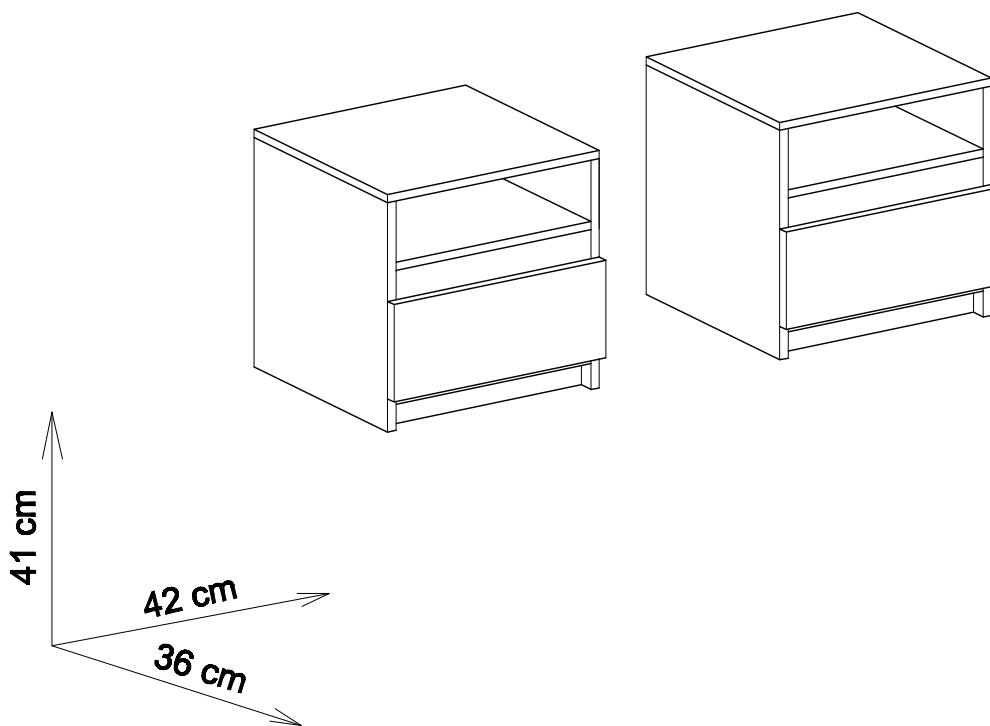

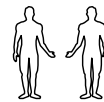
Pred montážou si dôkladne
preštudujte montážny návod.

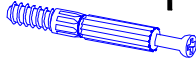
Poškodenia vzniknuté pri nesprávnej
montáži nebudú uznané ako reklamácia.

Mediolan nočný stolík

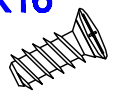

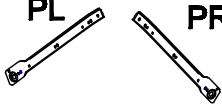
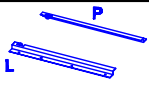

 T 40 ks	 M 40 ks	 K 64 ks	 SP 8 ks	 ZM 40 ks
 4X16 W2 8 ks	 KI 1 ks	 PL PR 2 ks	 P PD 2 ks	 SS 8 ks
<p>Číslovanie častí - v reklamačnom protokole prosím udávať celý alfanumerický kód</p>				 4X16 W5 16 ks

