

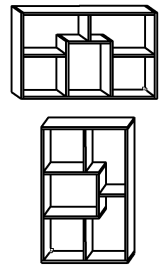

DOMINO A

➤ 97,4 ↑ 60 ↘ 20
➤ 60 ↑ 97,4 ↘ 20



x 6



(a)

x 18



(b)

x 18



(c)

x 15

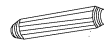

(d)

x 4



(e)

x 8

(6,2x13)



(f)

x 1



(g)

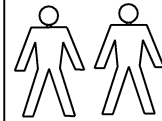

25 min



1 - FAZY MONTAŻU

A - OZNACZENIE ELEMENTÓW

a - OZNACZENIE AKCESORIÓW

1

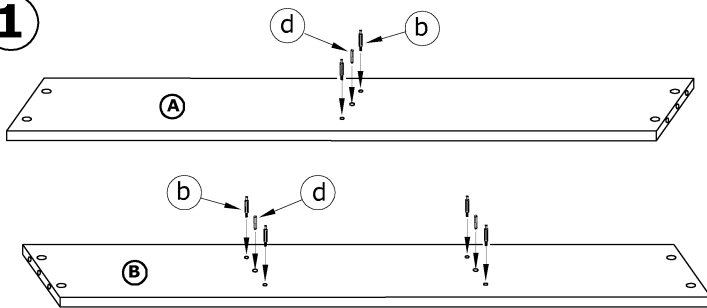

2

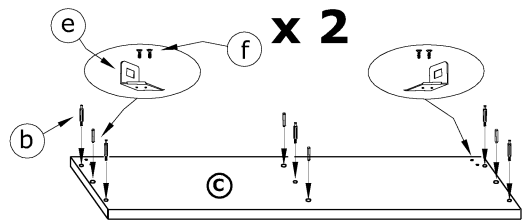

3

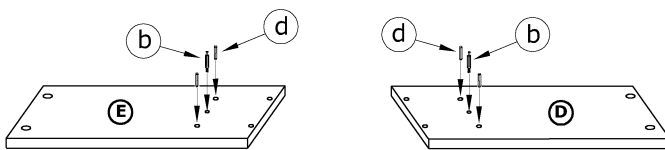

4

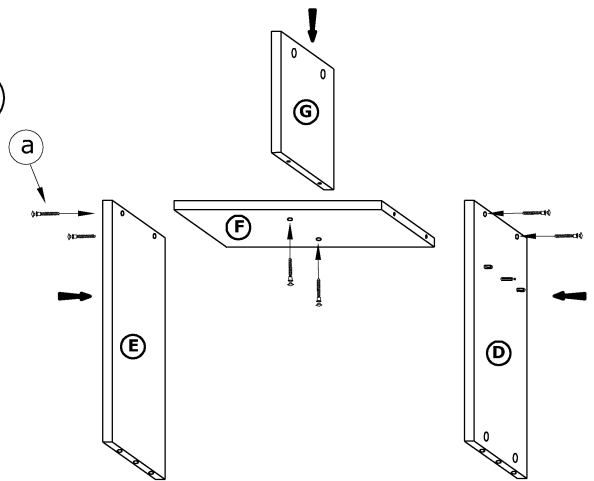

5

