

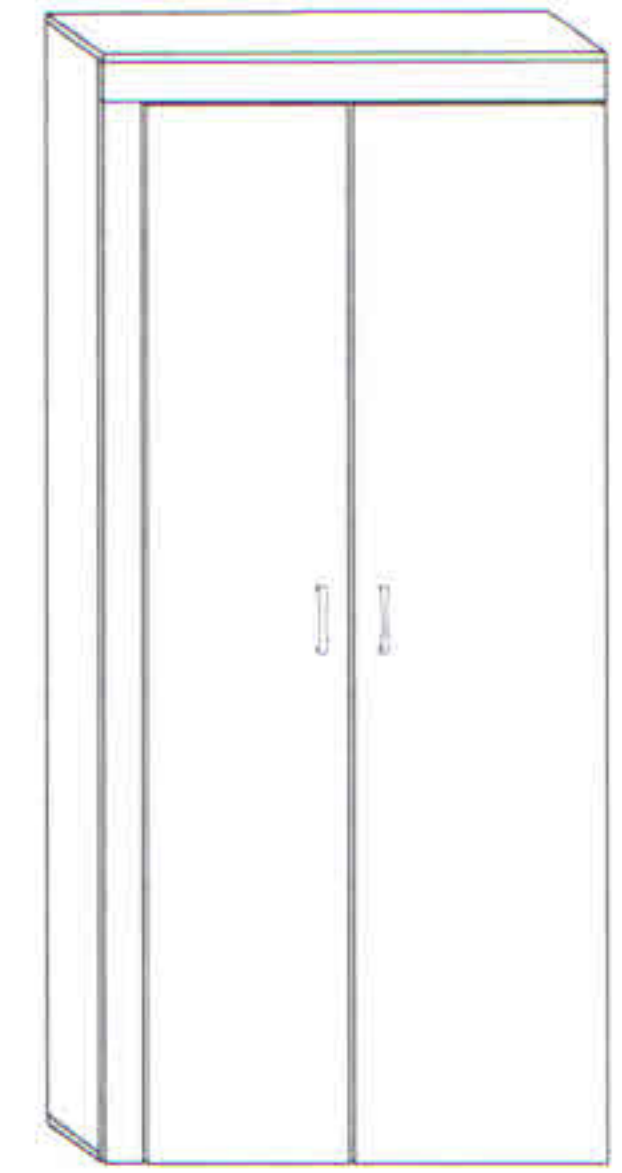

MAMBA - SZAFKA

→ 90 × 203 × 55



x 12

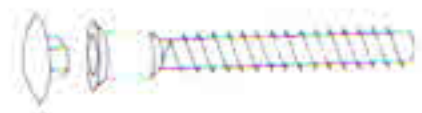

a

x 8



b

x 4



c

x 4



d

x 3

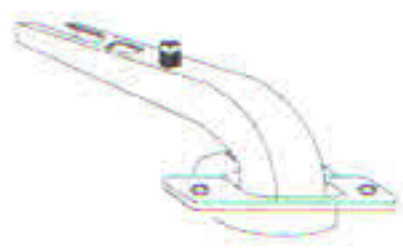

e

x 3

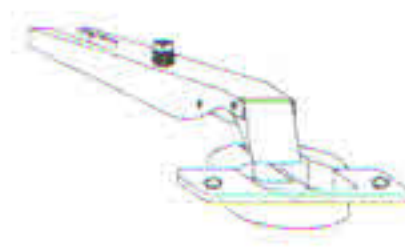

f

x 6



g

x 2



h

x 1 (865 mm)

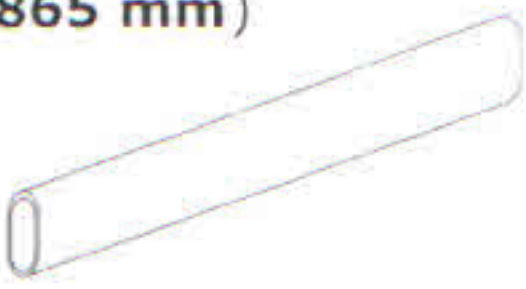

i

x 2

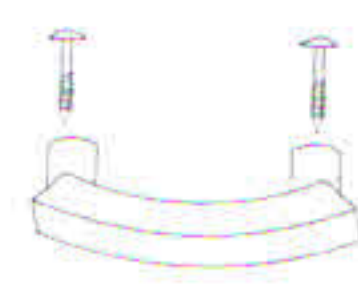

j

x 4

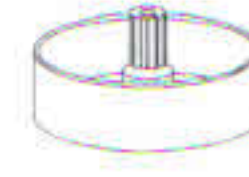

k

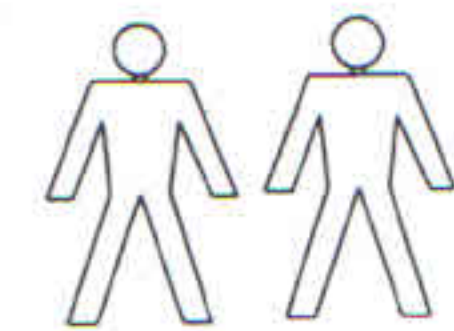

60 min



x 22
(4x16)



l

x 1



m

x 70



n

x 1



o

x 1



p

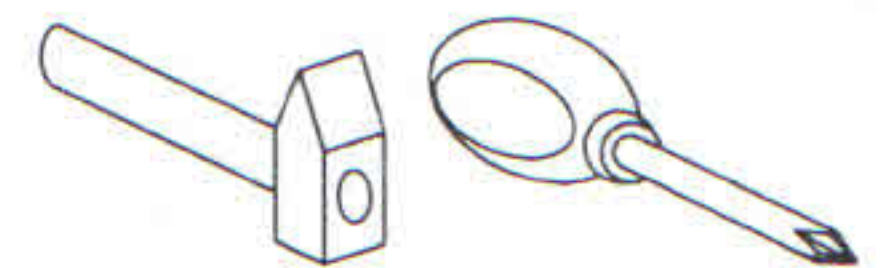

1 - FAZY MONTAŻU

A - OZNACZENIE ELEMENTÓW

a - OZNACZENIE AKCESORIÓW

1

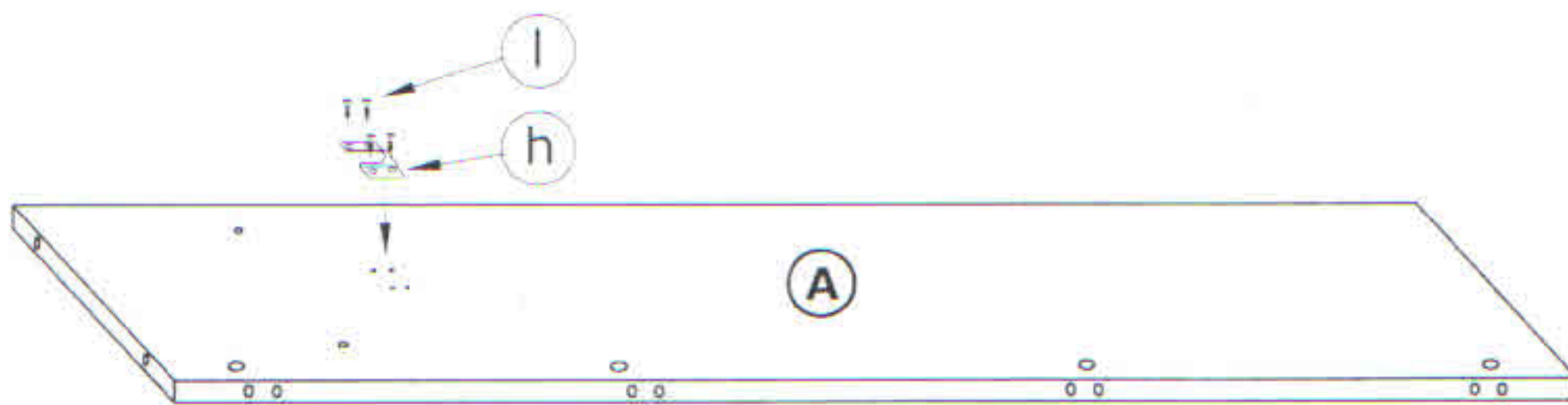

2

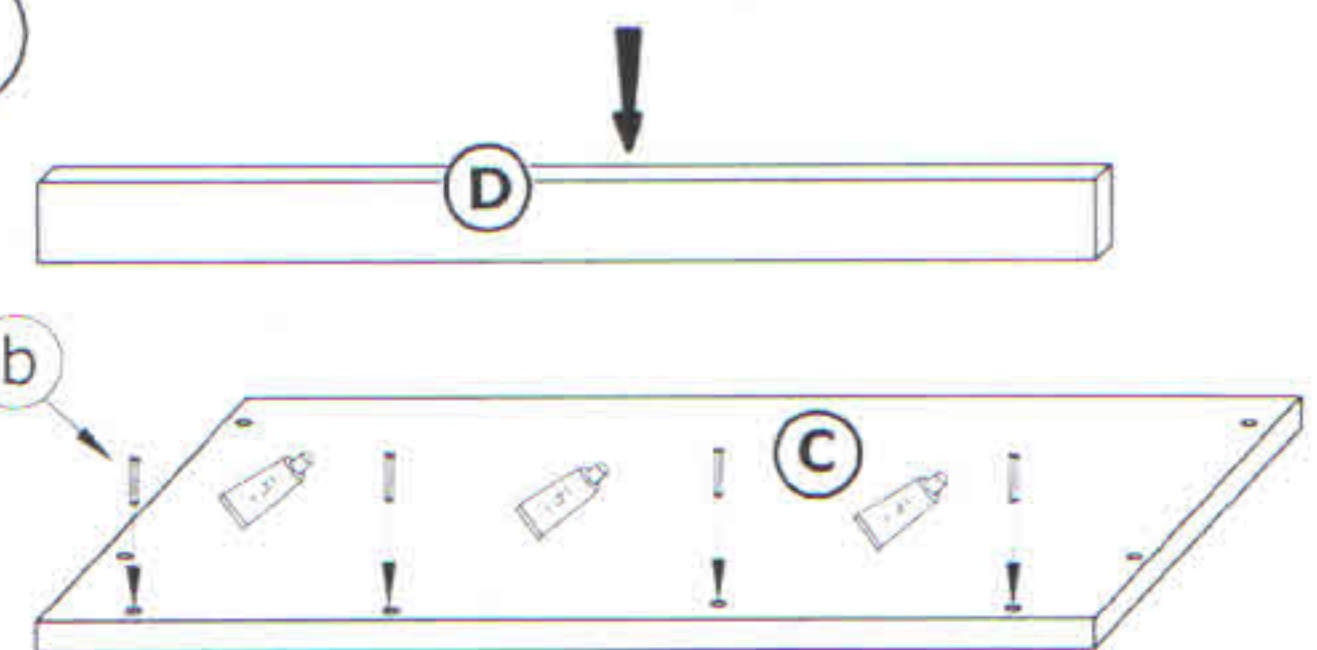

g

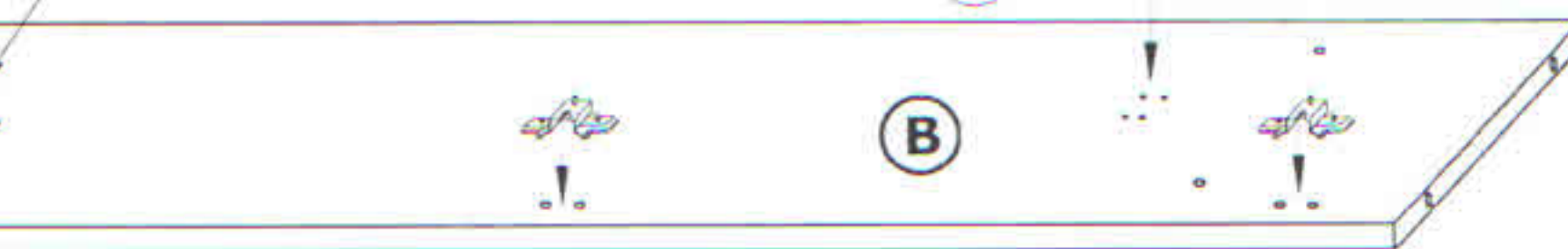

3

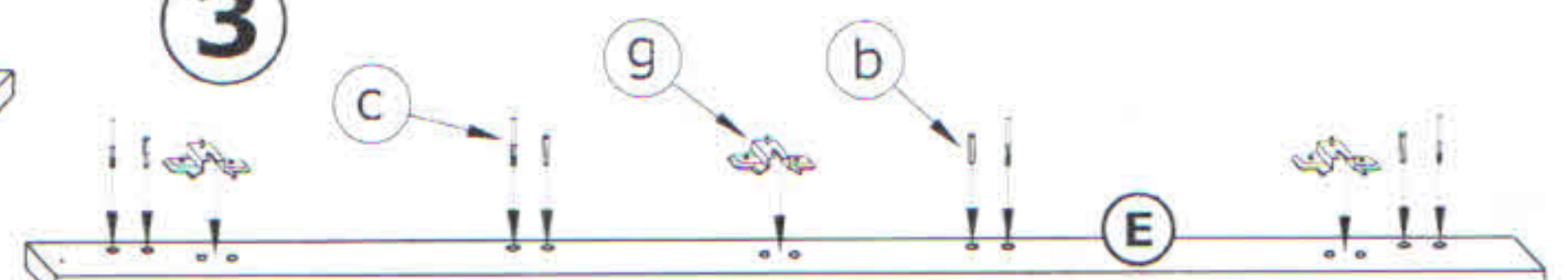

4

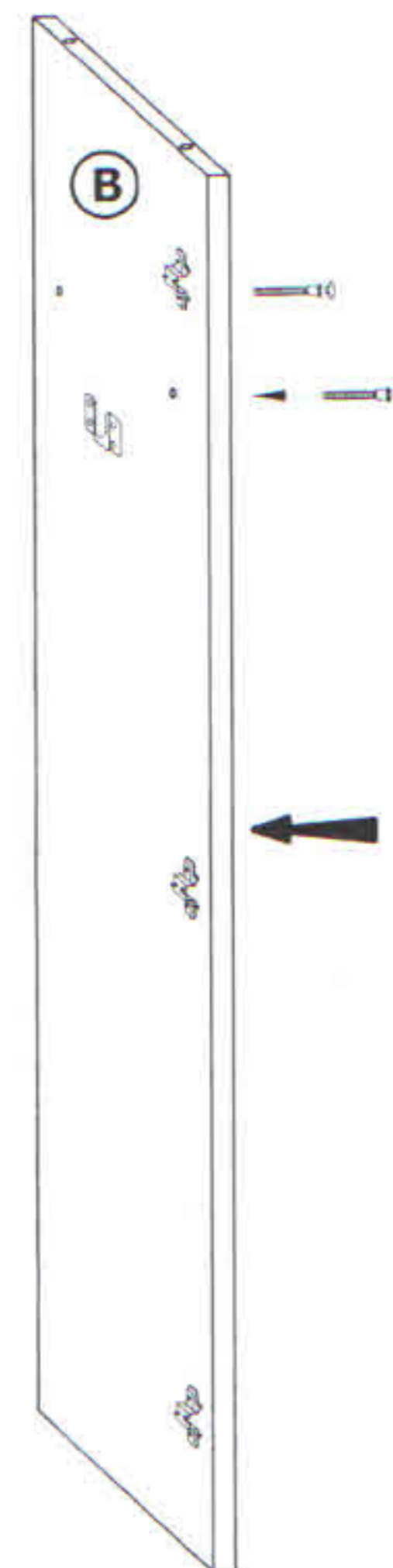
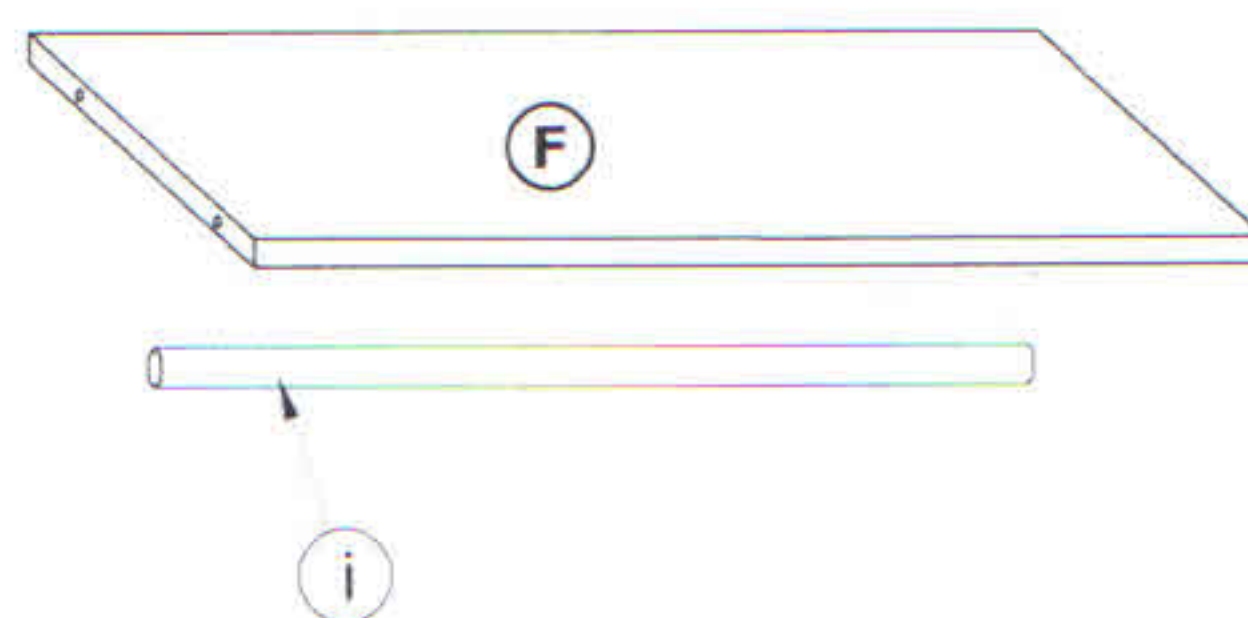
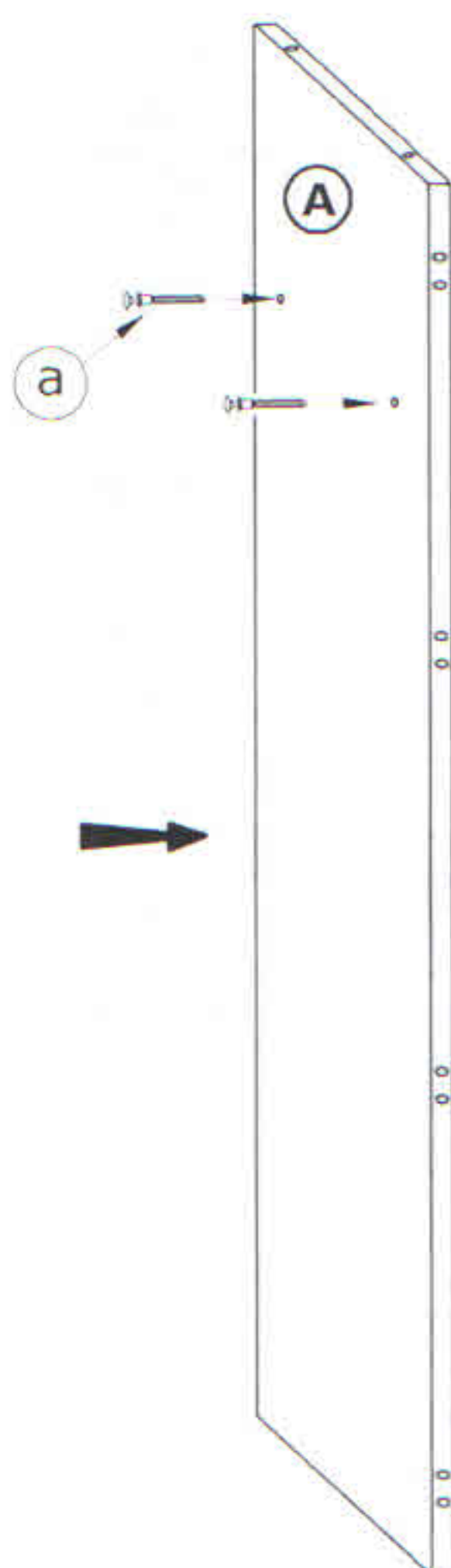

5

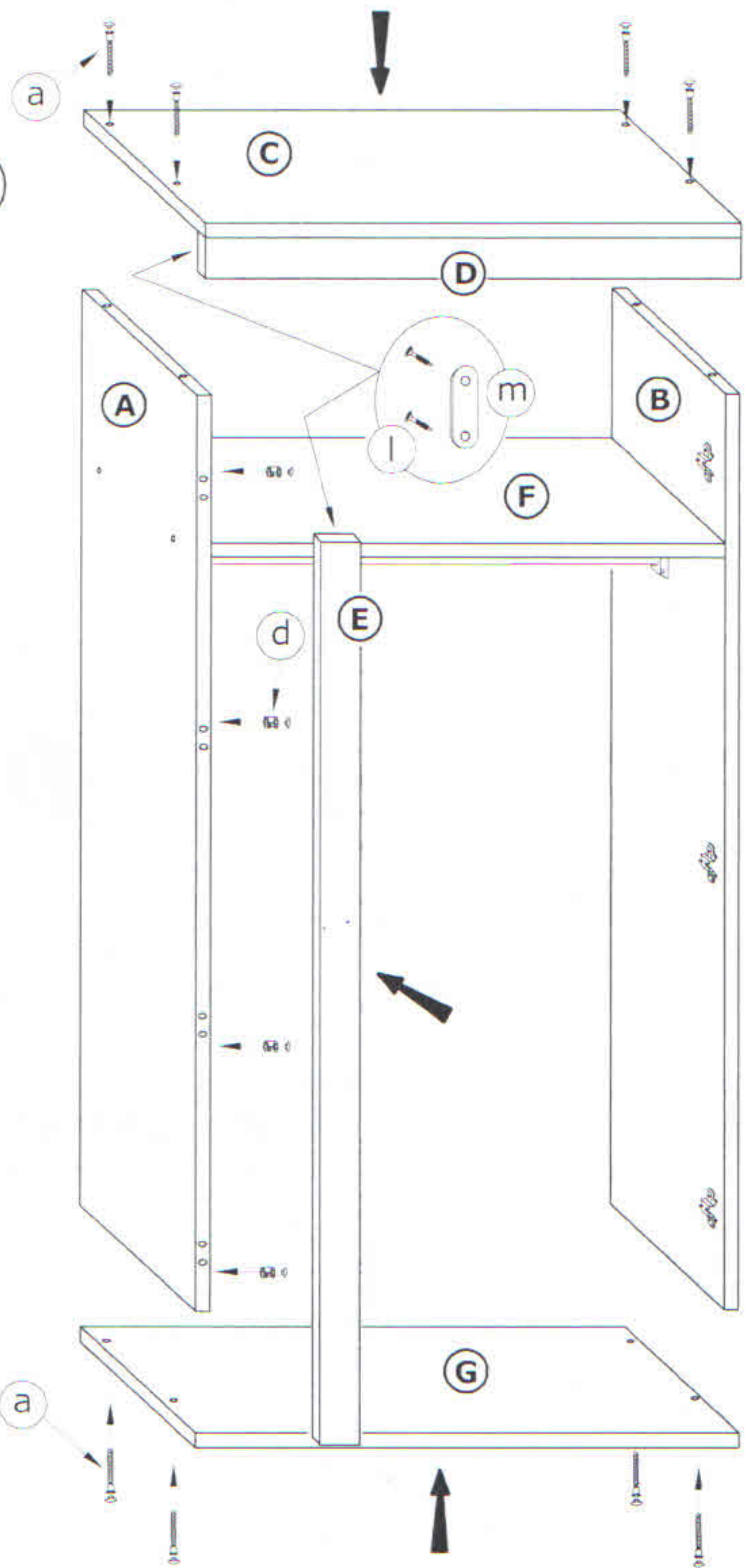

6

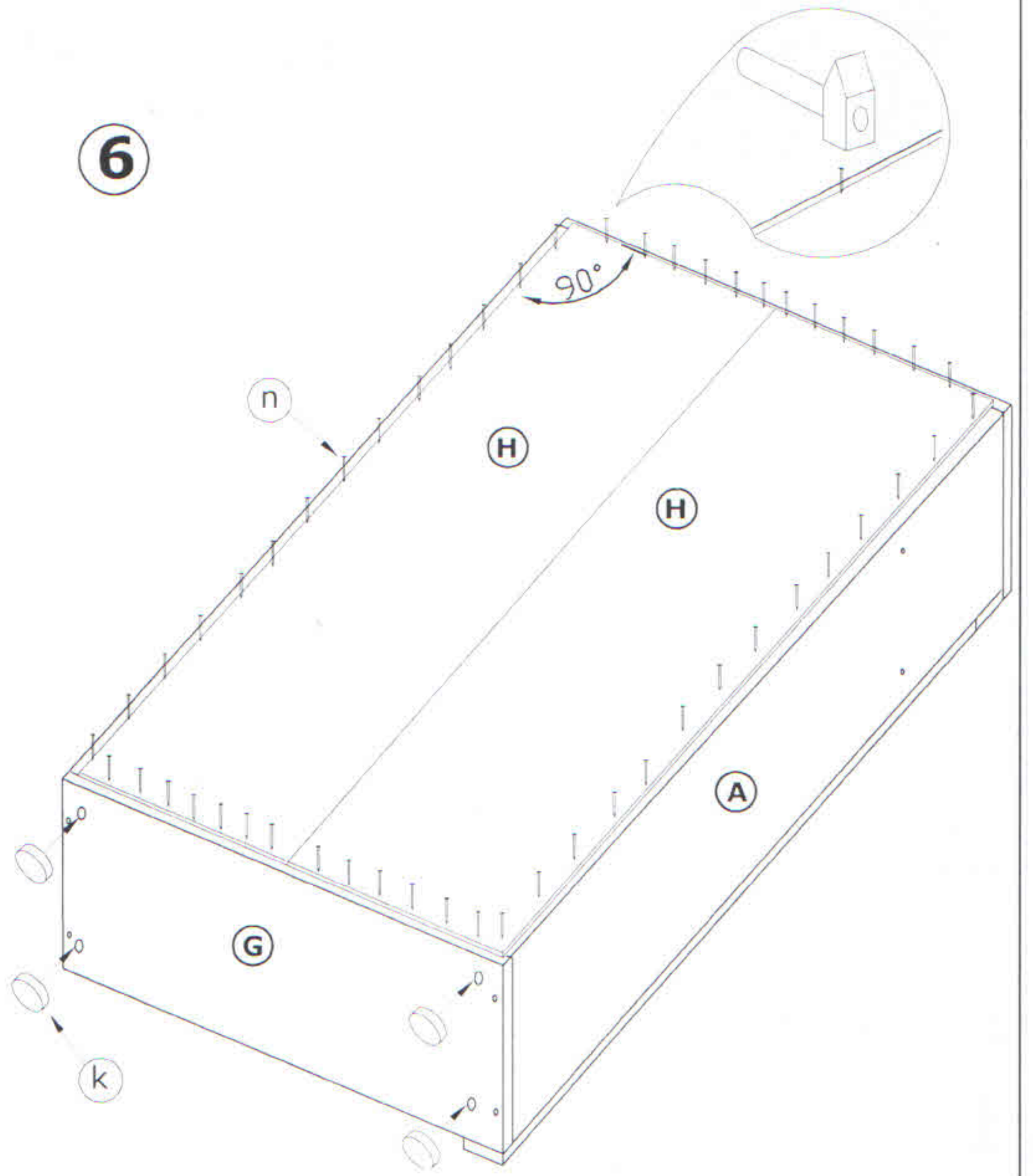

7

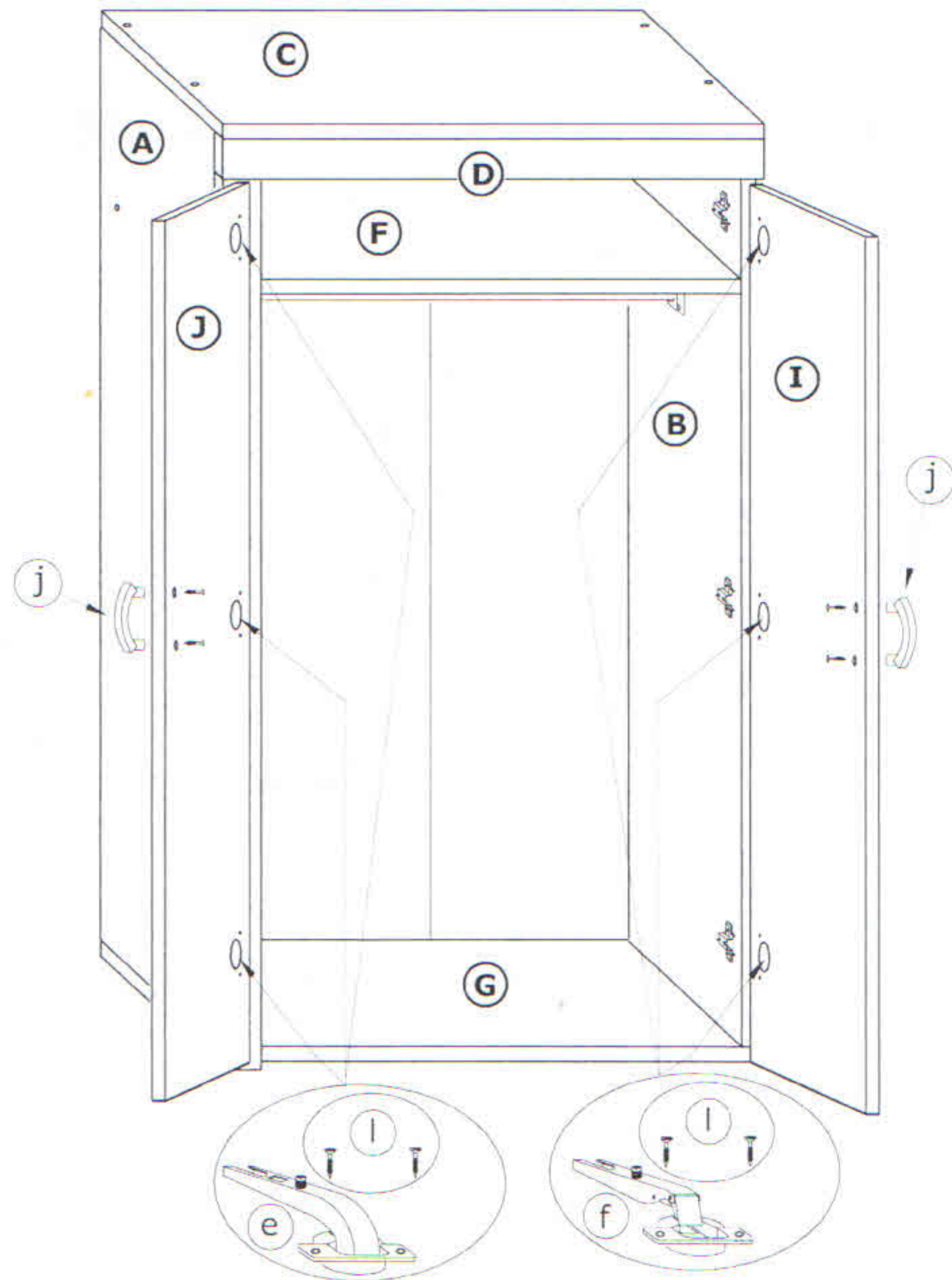

8

