

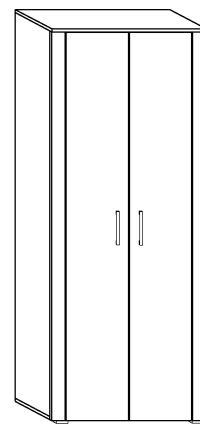

# NOT-07 NOTTI - SZAFKA

→ 80 ↑ 205 ↘ 56



x 8

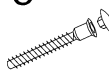

(a)

x 12

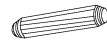

(b)

x 18

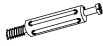

(c)

x 18



(d)

x 6

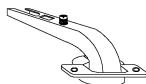

(e)

x 6



(f)

x 2



(g)

x 4

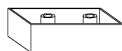

(h)

x 1 (762 mm)

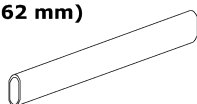

(i)

x 2



(j)

x 8 (4x20)



(k)

x 20 (3,5x16)



(l)

x 80

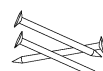

(m)

x 1

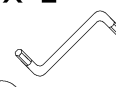

(n)

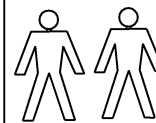

45 min



1 - FAZY MONTAŻU

A - OZNACZENIE ELEMENTÓW

a - OZNACZENIE AKCESORIÓW

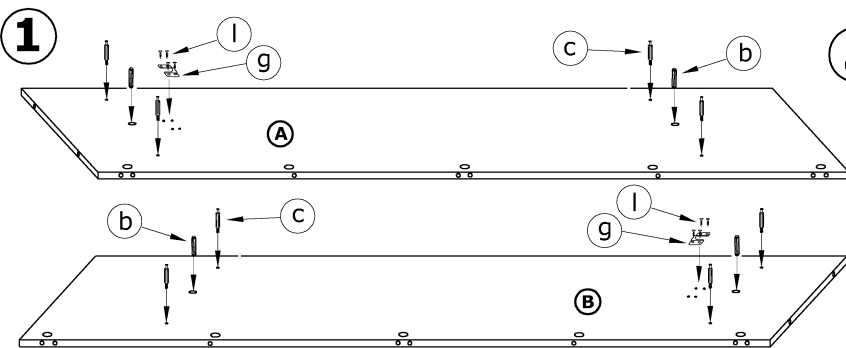

3

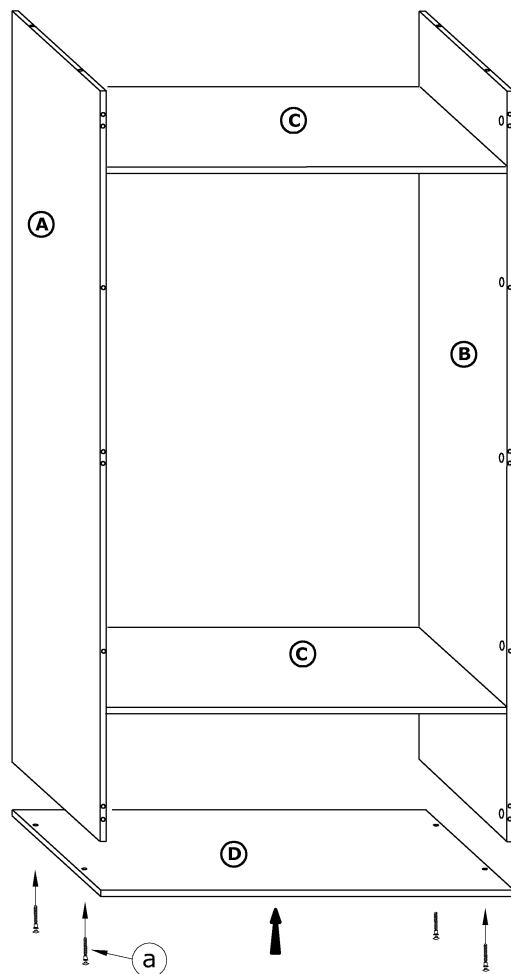
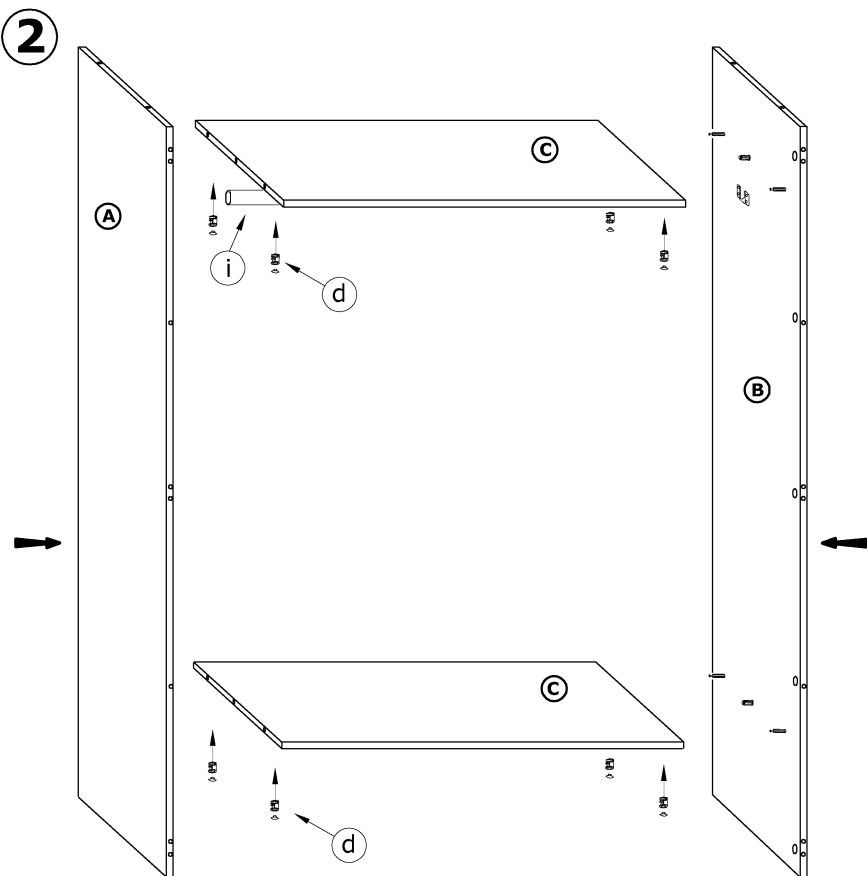
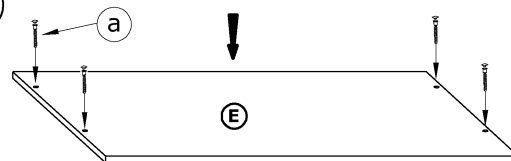

4

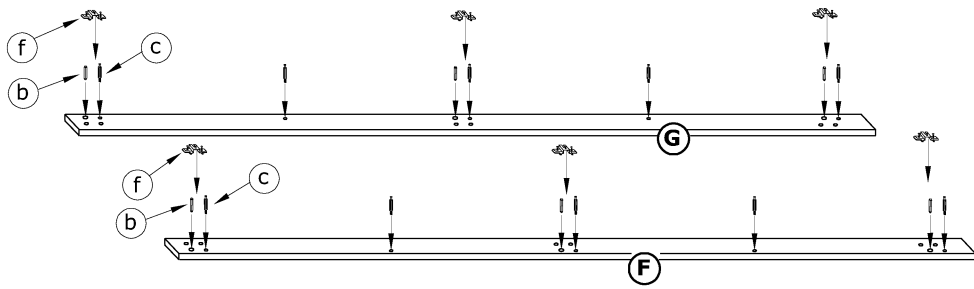

5

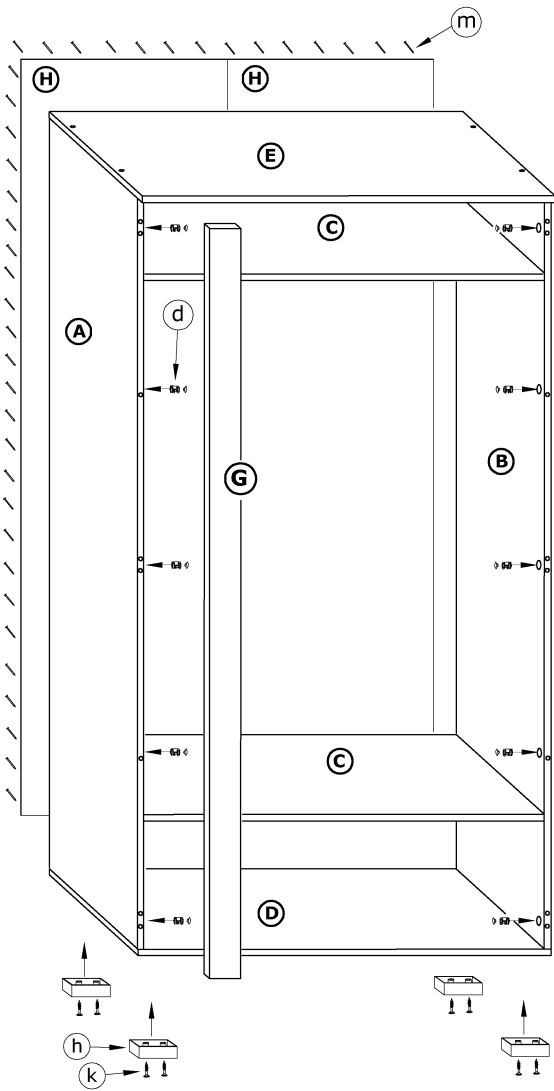

6

