

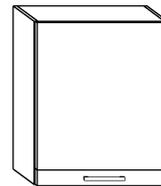

POLO - W60

→60 ↑72 ↘34



x 8



(a)

x 2



(b)

x 2

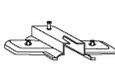

(c)

x 1



(d)

x 4



(e)

x 2



(f)

x 4 (4x16)



(g)

x 4 (3,5x30)



(h)

25 min



x 15



(i)

x 1



(j)

x 1



(k)



1 - FAZY MONTAŻU

A - OZNACZENIE ELEMENTÓW

a - OZNACZENIE AKCESORIÓW

1



2

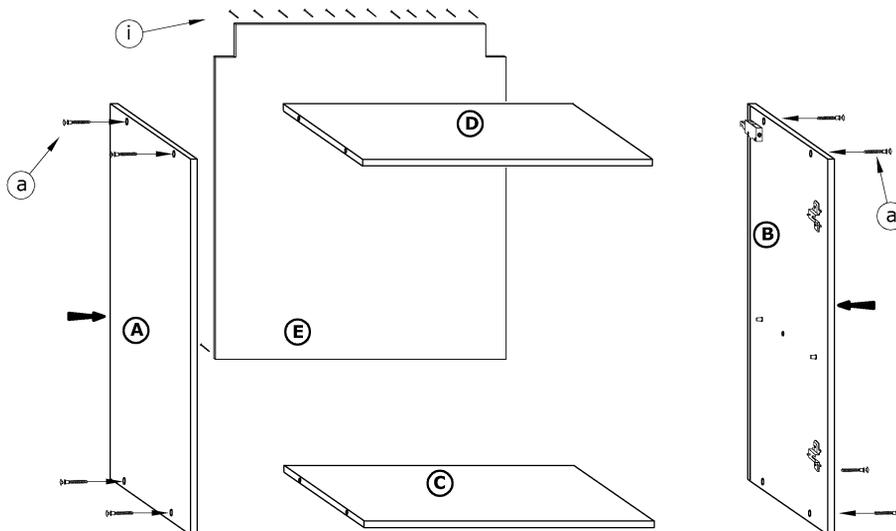

3

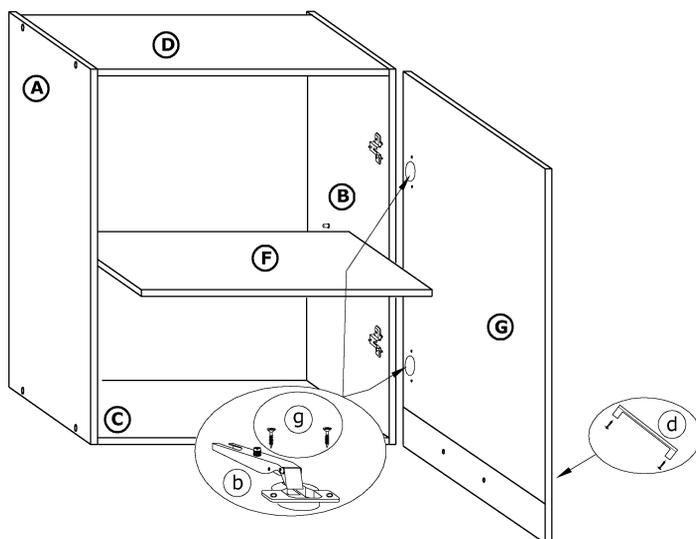

4

